

# SECTION 600

MISCELLANEOUS DESIGNS  
&  
SIGHT DISTANCE TABLES

STANDARD

THIS PAGE INTENTIONALLY LEFT BLANK



ROAD AND BRIDGE STANDARDS

SHEET 1 OF 1

REVISION DATE

TITLE

VIRGINIA DEPARTMENT OF TRANSPORTATION

SPECIFICATION  
REFERENCE

STANDARD	TITLE	PAGE
S-1	STANDARD CONCRETE STEPS FOR 1½:1 SLOPES	601.01
	STANDARD CONCRETE STEPS FOR 1½:1 SLOPES	601.02
S-2	STANDARD CONCRETE STEPS FOR 2:1 SLOPES	601.03
	STANDARD CONCRETE STEPS FOR 2:1 SLOPES	601.04
HR-1	STANDARD HANDRAILS (METHOD OF LOCATING AND ERECTING)	601.05
LR-1	MINIMUM DESIGN FOR SMALL BOAT LAUNCHING RAMPS AT PUBLIC LANDINGS	601.06
SP-1	SETTLEMENT PLATE	601.07
SI-1, 2, 3	STANDARD PLAN FOR SIGN ISLANDS	602.01
PE-1	STANDARD PRIVATE ENTRANCES	602.02
CR-1	STANDARD MAINTENANCE CROSSOVER FOR USE ON FREEWAYS	602.03
RFD-1	TURN OUT DETAIL	603.01
G-3	PRECAST CONCRETE CATTLE GUARD	604.01
G-3A	PRECAST CONCRETE CATTLE GUARD	604.02
NG-1	STORAGE FACILITY FOR NUCLEAR GAUGE	605.01
RU-1	METHODS OF UNDERCUTTING ROCK	606.01
SS-1	STANDARD METHOD OF SETTING AND MARKING SLOPE STAKES	607.01
SD-1	SIGHT DISTANCES ON HORIZONTAL CURVES HEIGHT OF EYE 3.5 FEET; HEIGHT OF OBJECT 2.0 AND 3.5 FEET	608.01
SD-2	SIGHT DISTANCE ON HORIZONTAL CURVES HEIGHT OF EYE 3.5 FEET; HEIGHT OF OBJECT 0.5	608.02
	SIGHT DISTANCE ON HORIZONTAL CURVES HEIGHT OF EYE 3.5 FEET; HEIGHT OF OBJECT 0.5	608.03
SD-3	SIGHT DISTANCES ON HORIZONTAL CURVES HEIGHT OF EYE 3.5 FEET; HEIGHT OF OBJECT 4.25 FEET	608.04
	SIGHT DISTANCES ON HORIZONTAL CURVES HEIGHT OF EYE 3.5 FEET; HEIGHT OF OBJECT 4.25 FEET	608.05
SD-4	SIGHT DISTANCES ON CREST VERTICAL CURVES HEIGHT OF EYE 3.5 FEET; HEIGHT OF OBJECT 2.00 FEET	608.06
	SIGHT DISTANCES ON CREST VERTICAL CURVES HEIGHT OF EYE 3.5 FEET; HEIGHT OF OBJECT 2.00 FEET	608.07
SD-5	SIGHT DISTANCES ON CREST VERTICAL CURVES HEIGHT OF EYE 3.5 FEET; HEIGHT OF OBJECT 3.50 FEET	608.08
	SIGHT DISTANCES ON CREST VERTICAL CURVES HEIGHT OF EYE 3.5 FEET; HEIGHT OF OBJECT 3.50 FEET	608.09

**INDEX OF SHEETS  
SECTION 600-MISC AND TABLES**

VIRGINIA DEPARTMENT OF TRANSPORTATION



ROAD AND BRIDGE STANDARDS

REVISION DATE	SHEET 1 OF 1
---------------	--------------

600.01

THIS PAGE INTENTIONALLY LEFT BLANK



ROAD AND BRIDGE STANDARDS

SHEET 1 OF 1

REVISION DATE

600.02

SPECIFICATION  
REFERENCE

VIRGINIA DEPARTMENT OF TRANSPORTATION

**FROM PICTORIAL VIEW IT IS SEEN THAT:**

$$V = \frac{V_1 W + 2V_2 (N-1) + V_3 (WN+1) + 2V_4}{27}$$

**SUBSTITUTING VALUES OF ELEMENTARY VOLUMES:**

$$V = \frac{0.917W + 1.146(N-1) + 0.726(WN+1) + 1.336}{27}$$

**SECTION A-A**

		NUMBER OF BARS A								
		N-1-5	N-6	N-7	N-8	N-9	N-10	N-11	N-12	N-13-25
W = 3'	NO STEEL	4	5	5	6	6	7	7	8	
		5	6	7	7	8	8	9	10	
		6	7	8	9	9	10	11	12	

**HANDRAIL IS TO BE PROVIDED FOR STEPS HAVING THREE OR MORE RISERS, AND WILL MEET THE FOLLOWING CONDITIONS:**

- ON STEPS LESS THAN 44 INCHES WIDE HAVING BOTH SIDES ENCLOSED, AT LEAST ONE HANDRAIL, PREFERABLY ON THE RIGHT SIDE DESCENDING.
- ON STEPS LESS THAN 44 INCHES WIDE HAVING ONE SIDE OPEN, ONE HANDRAIL ON EACH SIDE.
- ON STEPS LESS THAN 44 INCHES WIDE HAVING BOTH SIDES OPEN, ONE HANDRAIL ON EACH SIDE.
- ON STEPS MORE THAN 44 INCHES WIDE BUT LESS THAN 88 INCHES WIDE, ONE HANDRAIL ON EACH SIDE.
- ON STEPS 88 OR MORE INCHES WIDE, ONE HANDRAIL ON EACH SIDE, AND ONE INTERMEDIATE HANDRAIL LOCATED APPROXIMATELY MIDWAY OF THE WIDTH.

SPECIFICATION REFERENCE

105  
504

# STANDARD CONCRETE STEPS FOR 1 1/2:1 SLOPE

VIRGINIA DEPARTMENT OF TRANSPORTATION

**VDOT**

ROAD AND BRIDGE STANDARDS

REVISION DATE

SHEET 1 OF 2

601.01

S-1

TABLE OF QUANTITIES

N	W = 3'		W = 4'		W = 5'		INCREMENTS *		N
	CONCRETE	REINF. STEEL	CONCRETE	REINF. STEEL	CONCRETE	REINF. STEEL	CONCRETE	REINF. STEEL	
	Cu. Yards	LBS.	Cu. Yards	LBS.	Cu. Yards	LBS.	Cu. Yards	LBS.	
1	0.259		0.320		0.381		0.061		1
2	0.382		0.470		0.558		0.088		2
3	0.505		0.620		0.734		0.115		3
4	0.628		0.770		0.911		0.142		4
5	0.751		0.920		1.088		0.168		5
6	0.874	50	1.070	60	1.265	70	0.195	10	6
7	0.998	62	1.220	74	1.442	85	0.222	12	7
8	1.121	70	1.370	89	1.619	102	0.249	13	8
9	1.244	84	1.520	99	1.796	120	0.276	14	9
10	1.367	93	1.670	116	1.973	132	0.303	16	10
11	1.490	110	1.820	127	2.150	149	0.330	17	11
12	1.613	119	1.970	146	2.326	174	0.357	19	12
13	1.736	137	2.120	167	2.503	197	0.384	30	13
14	1.859	147	2.270	179	2.680	211	0.410	32	14
15	1.983	157	2.420	191	2.857	225	0.437	34	15
16	2.106	167	2.570	203	3.034	239	0.464	36	16
17	2.229	177	2.720	215	3.211	253	0.491	38	17
18	2.352	186	2.870	227	3.388	267	0.518	40	18
19	2.476	196	3.020	239	3.565	281	0.545	43	19
20	2.598	206	3.170	251	3.742	295	0.572	45	20
21	2.721	216	3.320	262	3.918	309	0.599	47	21
22	2.844	225	3.470	274	4.095	323	0.626	49	22
23	2.967	235	3.620	286	4.272	337	0.652	51	23
24	3.091	245	3.770	298	4.449	351	0.679	53	24
25	3.214	255	3.920	310	4.626	365	0.706	55	25

\* Increments to be added for each additional foot of width.

N - Indicates number of steps exclusive of landing.

W - Indicates width between sidewalks.

For detail drawings and dimensions of steps see sheet 1 of 2.



ROAD AND BRIDGE STANDARDS

STANDARD CONCRETE STEPS FOR 1 1/2:1 SLOPE

SPECIFICATION REFERENCE

SHEET 2 OF 2

REVISION DATE

601.02

VIRGINIA DEPARTMENT OF TRANSPORTATION

105  
504

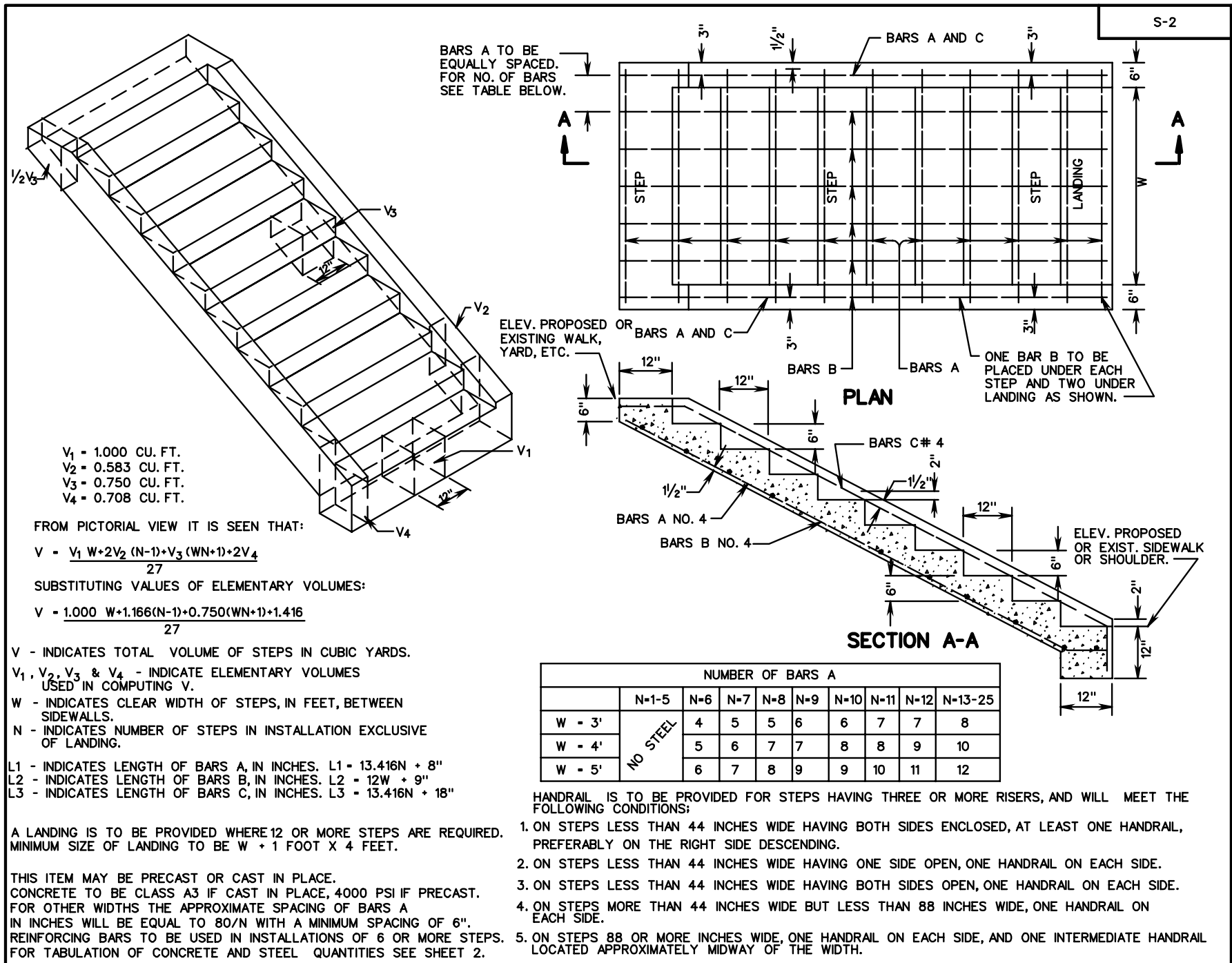

$V_1 = 1.000$  CU. FT.  
 $V_2 = 0.583$  CU. FT.  
 $V_3 = 0.750$  CU. FT.  
 $V_4 = 0.708$  CU. FT.

FROM PICTORIAL VIEW IT IS SEEN THAT:

$$V = \frac{V_1 W + 2V_2 (N-1) + V_3 (WN+1) + 2V_4}{27}$$

SUBSTITUTING VALUES OF ELEMENTARY VOLUMES:

$$V = \frac{1.000 W + 1.166(N-1) + 0.750(WN+1) + 1.416}{27}$$

V - INDICATES TOTAL VOLUME OF STEPS IN CUBIC YARDS.

$V_1, V_2, V_3$  &  $V_4$  - INDICATE ELEMENTARY VOLUMES USED IN COMPUTING V.

W - INDICATES CLEAR WIDTH OF STEPS, IN FEET, BETWEEN SIDEWALLS.

N - INDICATES NUMBER OF STEPS IN INSTALLATION EXCLUSIVE OF LANDING.

L1 - INDICATES LENGTH OF BARS A, IN INCHES.  $L1 = 13.416N + 8''$   
 L2 - INDICATES LENGTH OF BARS B, IN INCHES.  $L2 = 12W + 9''$   
 L3 - INDICATES LENGTH OF BARS C, IN INCHES.  $L3 = 13.416N + 18''$

A LANDING IS TO BE PROVIDED WHERE 12 OR MORE STEPS ARE REQUIRED. MINIMUM SIZE OF LANDING TO BE  $W + 1$  FOOT X 4 FEET.

THIS ITEM MAY BE PRECAST OR CAST IN PLACE. CONCRETE TO BE CLASS A3 IF CAST IN PLACE, 4000 PSI IF PRECAST. FOR OTHER WIDTHS THE APPROXIMATE SPACING OF BARS A IN INCHES WILL BE EQUAL TO  $80/N$  WITH A MINIMUM SPACING OF 6". REINFORCING BARS TO BE USED IN INSTALLATIONS OF 6 OR MORE STEPS. FOR TABULATION OF CONCRETE AND STEEL QUANTITIES SEE SHEET 2.

HANDRAIL IS TO BE PROVIDED FOR STEPS HAVING THREE OR MORE RISERS, AND WILL MEET THE FOLLOWING CONDITIONS:

- ON STEPS LESS THAN 44 INCHES WIDE HAVING BOTH SIDES ENCLOSED, AT LEAST ONE HANDRAIL, PREFERABLY ON THE RIGHT SIDE DESCENDING.
- ON STEPS LESS THAN 44 INCHES WIDE HAVING ONE SIDE OPEN, ONE HANDRAIL ON EACH SIDE.
- ON STEPS LESS THAN 44 INCHES WIDE HAVING BOTH SIDES OPEN, ONE HANDRAIL ON EACH SIDE.
- ON STEPS MORE THAN 44 INCHES WIDE BUT LESS THAN 88 INCHES WIDE, ONE HANDRAIL ON EACH SIDE.
- ON STEPS 88 OR MORE INCHES WIDE, ONE HANDRAIL ON EACH SIDE, AND ONE INTERMEDIATE HANDRAIL LOCATED APPROXIMATELY MIDWAY OF THE WIDTH.

SPECIFICATION REFERENCE	<h1>STANDARD CONCRETE STEPS FOR 2:1 SLOPE</h1>	<b>VDOT</b>	
105 504		ROAD AND BRIDGE STANDARDS	
		REVISION DATE	SHEET 1 OF 2
	VIRGINIA DEPARTMENT OF TRANSPORTATION	601.03	

TABLE OF QUANTITIES

N	W - 3'		W - 4'		W - 5'		INCREMENTS *		N
	CONCRETE	REINF. STEEL	CONCRETE	REINF. STEEL	CONCRETE	REINF. STEEL	CONCRETE	REINF. STEEL	
	CU. YARDS	LBS.	CU. YARDS	LBS.	CU. YARDS	LBS.	CU. YARDS	LBS.	
1	0.275		0.340		0.405		0.065		1
2	0.401		0.494		0.587		0.093		2
3	0.528		0.648		0.768		0.120		3
4	0.654		0.802		0.950		0.148		4
5	0.781		0.957		1.133		0.176		5
6	0.907	51	1.111	61	1.315	71	0.204	10	6
7	1.034	63	1.265	75	1.496	87	0.231	12	7
8	1.160	71	1.419	91	1.678	104	0.259	13	8
9	1.287	86	1.574	101	1.861	122	0.287	15	9
10	1.413	94	1.728	118	2.043	134	0.315	16	10
11	1.540	112	1.883	129	2.226	155	0.343	17	11
12	1.666	121	2.036	149	2.406	177	0.370	19	12
13	1.793	140	2.191	171	2.589	201	0.398	30	13
14	1.919	150	2.345	183	2.771	215	0.426	32	14
15	2.046	160	2.500	195	2.954	229	0.454	35	15
16	2.172	170	2.653	207	3.134	244	0.481	37	16
17	2.299	180	2.808	219	3.317	258	0.509	39	17
18	2.425	190	2.962	231	3.499	272	0.537	41	18
19	2.552	200	3.117	243	3.682	287	0.565	43	19
20	2.678	210	3.271	256	3.864	301	0.593	45	20
21	2.805	220	3.425	268	4.045	315	0.620	48	21
22	2.931	230	3.579	280	4.227	330	0.648	50	22
23	3.058	240	3.734	292	4.410	344	0.676	52	23
24	3.184	250	3.888	304	4.592	358	0.704	54	24
25	3.311	260	4.042	316	4.773	372	0.731	56	25

\* Increments to be added for each additional foot of width.

N - Indicates number of steps exclusive of landing.

W - Indicates width between sidewalls.

For detail drawings and dimensions of steps see sheet 1.



ROAD AND BRIDGE STANDARDS

SHEET 2 OF 2

REVISION DATE

601.04

STANDARD CONCRETE STEPS FOR 2:1 SLOPE

VIRGINIA DEPARTMENT OF TRANSPORTATION

SPECIFICATION REFERENCE

105  
504



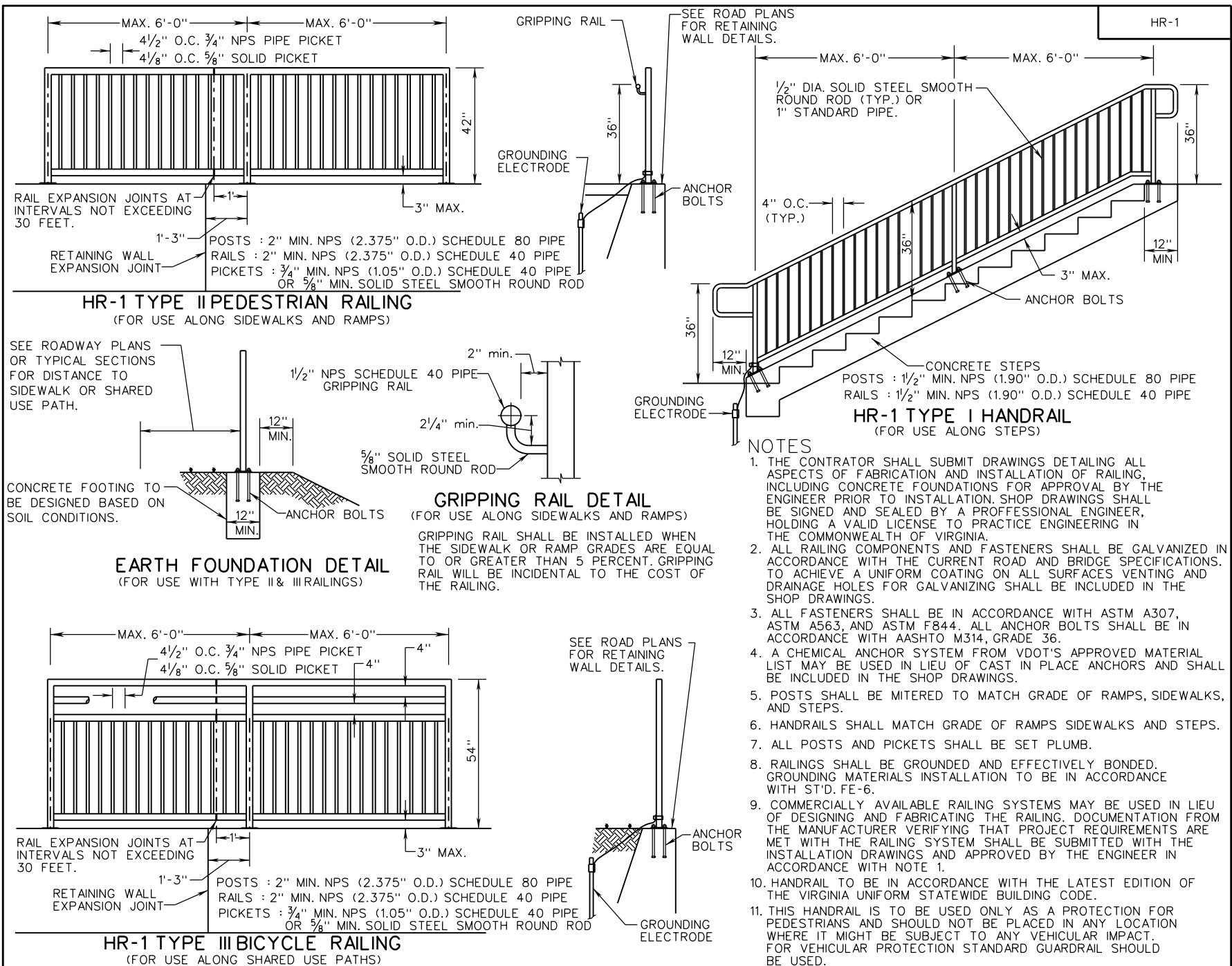

**HR-1 TYPE II PEDESTRIAN RAILING**  
(FOR USE ALONG SIDEWALKS AND RAMPS)

**HR-1 TYPE I HANDRAIL**  
(FOR USE ALONG STEPS)

**EARTH FOUNDATION DETAIL**  
(FOR USE WITH TYPE II & III RAILINGS)

**GRIPPING RAIL DETAIL**  
(FOR USE ALONG SIDEWALKS AND RAMPS)

**NOTES**

1. THE CONTRACTOR SHALL SUBMIT DRAWINGS DETAILING ALL ASPECTS OF FABRICATION AND INSTALLATION OF RAILING, INCLUDING CONCRETE FOUNDATIONS FOR APPROVAL BY THE ENGINEER PRIOR TO INSTALLATION. SHOP DRAWINGS SHALL BE SIGNED AND SEALED BY A PROFESSIONAL ENGINEER, HOLDING A VALID LICENSE TO PRACTICE ENGINEERING IN THE COMMONWEALTH OF VIRGINIA.
2. ALL RAILING COMPONENTS AND FASTENERS SHALL BE GALVANIZED IN ACCORDANCE WITH THE CURRENT ROAD AND BRIDGE SPECIFICATIONS. TO ACHIEVE A UNIFORM COATING ON ALL SURFACES VENTING AND DRAINAGE HOLES FOR GALVANIZING SHALL BE INCLUDED IN THE SHOP DRAWINGS.
3. ALL FASTENERS SHALL BE IN ACCORDANCE WITH ASTM A307, ASTM A563, AND ASTM F844. ALL ANCHOR BOLTS SHALL BE IN ACCORDANCE WITH AASHTO M314, GRADE 36.
4. A CHEMICAL ANCHOR SYSTEM FROM VDOT'S APPROVED MATERIAL LIST MAY BE USED IN LIEU OF CAST IN PLACE ANCHORS AND SHALL BE INCLUDED IN THE SHOP DRAWINGS.
5. POSTS SHALL BE MITERED TO MATCH GRADE OF RAMPS, SIDEWALKS, AND STEPS.
6. HANDRAILS SHALL MATCH GRADE OF RAMPS, SIDEWALKS AND STEPS.
7. ALL POSTS AND PICKETS SHALL BE SET PLUMB.
8. RAILINGS SHALL BE GROUNDED AND EFFECTIVELY BONDED. GROUNDED MATERIALS INSTALLATION TO BE IN ACCORDANCE WITH STD. FE-6.
9. COMMERCIALY AVAILABLE RAILING SYSTEMS MAY BE USED IN LIEU OF DESIGNING AND FABRICATING THE RAILING. DOCUMENTATION FROM THE MANUFACTURER VERIFYING THAT PROJECT REQUIREMENTS ARE MET WITH THE RAILING SYSTEM SHALL BE SUBMITTED WITH THE INSTALLATION DRAWINGS AND APPROVED BY THE ENGINEER IN ACCORDANCE WITH NOTE 1.
10. HANDRAIL TO BE IN ACCORDANCE WITH THE LATEST EDITION OF THE VIRGINIA UNIFORM STATEWIDE BUILDING CODE.
11. THIS HANDRAIL IS TO BE USED ONLY AS A PROTECTION FOR PEDESTRIANS AND SHOULD NOT BE PLACED IN ANY LOCATION WHERE IT MIGHT BE SUBJECT TO ANY VEHICULAR IMPACT. FOR VEHICULAR PROTECTION STANDARD GUARDRAIL SHOULD BE USED.

SPECIFICATION REFERENCE	A COPY OF THE ORIGINAL SEALED AND SIGNED DRAWING IS ON FILE IN THE CENTRAL OFFICE.		VDOT ROAD AND BRIDGE STANDARDS			
	105 238 504	<p><b>STANDARD HANDRAIL</b> <b>METHOD OF LOCATING AND ERECTING</b> VIRGINIA DEPARTMENT OF TRANSPORTATION</p>		<table border="1"> <tr> <td>REVISION DATE</td> <td>SHEET 1 OF 1</td> </tr> <tr> <td>7/11</td> <td>601.05</td> </tr> </table>	REVISION DATE	SHEET 1 OF 1
REVISION DATE	SHEET 1 OF 1					
7/11	601.05					

LR-1

NOTES:

1. THE MINIMUM SLAB WIDTH IS TO BE 16'.
2. SLAB DETAILS ARE TO BE IN ACCORDANCE WITH STANDARD PLAN PR-2 EXCEPT THAT EXPANSION, CONTRACTION, AND LONGITUDINAL JOINTS MAY BE ELIMINATED UNLESS REQUIRED BY THE ENGINEER.
3. STEEL FABRIC SLAB REINFORCEMENT SHALL CONSIST OF MEMBERS RIGIDLY ATTACHED AT ALL JOINTS OR POINTS OF INTERSECTION AND SHALL HAVE AN EFFECTIVE WEIGHT OF NOT LESS THAN 61 LBS./100 SQ.FT. LONGITUDINAL MEMBERS SHALL BE OF NO. 1 GAGE WIRE SPACED AT 6" O-C. TRANSVERSE MEMBERS SHALL BE OF NO. 4 GAGE WIRE SPACED AT 12" O-C. ALTERNATE GRADE 60 NO. 4 REBARS 12" O-C EACHWAY CENTERED IN SLAB.
4. SLAB IS TO BE CONSTRUCTED ON EITHER A STRAIGHT GRADE OR WITH VERTICAL CURVES WITH A RATE OF CHANGE PER FOOT OF LESS THAN 2%.
5. THE GRADIENT OF SLAB IS TO BE 12-15%. RAMPS CONSTRUCTED IN SALT WATER WITH THE POSSIBILITY OF LARGER BOATS USING THE RAMP SHOULD BE DESIGNED USING THE LOWER END OF THIS RANGE.
6. ALL REINFORCING STEEL MEMBERS ARE TO HAVE A MINIMUM OF 3" CONCRETE COVER AT EDGES OF SLAB. MESH REINFORCEMENT IS TO BE PLACED 2" FROM TOP OF SLAB.
7. FINAL FINISH OF SLAB IS TO BE OBTAINED BY THE USE OF A STEEL RAKE (WITH TINES BENT AWAY FROM THE DIRECTION OF PULL) DRAWN TRANSVERSLY TO AXIS OF SLAB (PARALLEL TO WATER LINE).
8. PORTIONS OF SLAB WHICH WILL ULTIMATELY BE BELOW WATER LEVEL ARE TO BE PROTECTED DURING POURING, FINISHING, AND CURING BY THE USE OF COFFERDAMS, CRIBS, OR OTHER METHODS MEETING THE APPROVAL OF THE ENGINEER.
9. CLASS 1 DRY RIP RAP TO BE IN ACCORDANCE WITH ROAD AND BRIDGE SPECIFICATIONS.
10. SUITABLE PARKING AREAS FOR VEHICLES AND TRAILER ARE TO BE PROVIDED OFF OF RAMP.
11. RAMP SHOULD BE ANGLED DOWNSTREAM IN RIVER SITUATIONS AT THE DISCRETION OF THE ENGINEER.
12. ON FLOWING RIVER SITUATIONS COURTESY PIERS ARE NOT DESIRABLE, ON ALL OTHER SITUATIONS A COURTESY PIER IS DESIRABLE.
13. LAUNCH RAMPS AND PARKING AREAS SHOULD BE FREE OF OVERHEAD OBSTRUCTIONS, ESPECIALLY ELECTRICAL WIRES.
14. THESE FACILITIES SHOULD BE HANDICAPPED ACCESSIBLE TO THE TOP OF BOAT RAMP AND COURTESY PIER IF PROVIDED.
15. WHERE WAVE OR TIDAL ACTION OCCUR, THE RIP RAP LENGTH ABOVE MEAN HIGH WATER SHALL BE EXTENDED TO DISSIPATE WATER VELOCITIES.

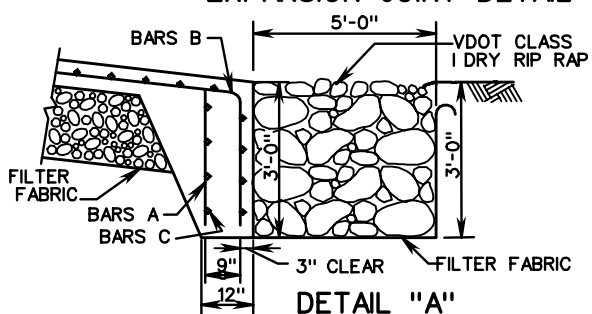
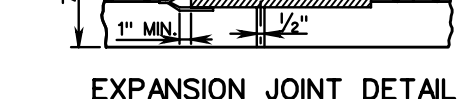
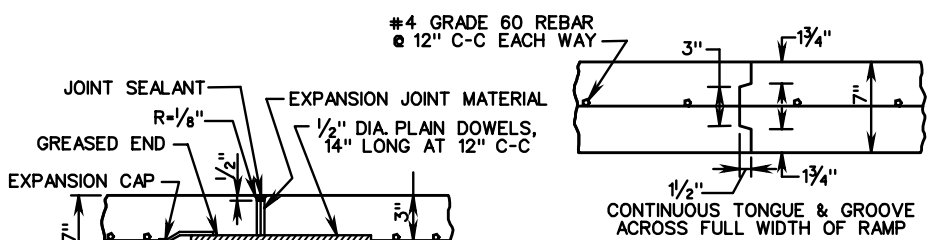
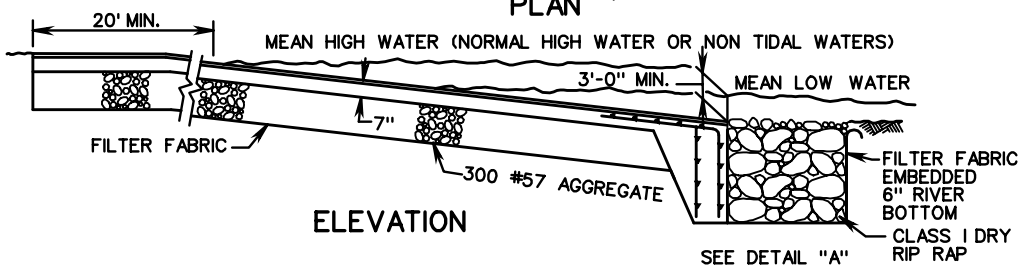
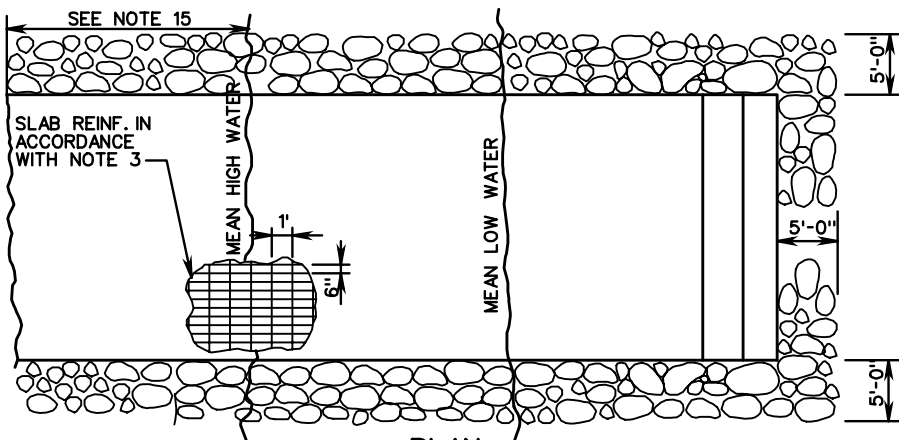

CONTRACTION JOINT DETAIL

SCHEDULE OF REINFORCING STEEL					
		2'-8"		1'-10"	
BEND TO FIT GRADE BARS "B"					
BAR	SIZE	NO.	LENGTH	SPACING C-C	
A	# 4	*	2'-0"	1'-0"	STRAIGHT
B	# 4	*	4'-6"	1'-0"	BENT
C	# 4	8	* *	9" AND AS SHOWN	STRAIGHT
* NO. OF BARS EQUALS SLAB WIDTH IN FEET.					
** SLAB WIDTH MINUS 6"					

**VDOT**  
ROAD AND BRIDGE STANDARDS

SHEET 1 OF 1      REVISION DATE

601.06

**MINIMUM DESIGN FOR SMALL BOAT LAUNCHING RAMPS AT PUBLIC LANDINGS**

VIRGINIA DEPARTMENT OF TRANSPORTATION

SPECIFICATION REFERENCE

316

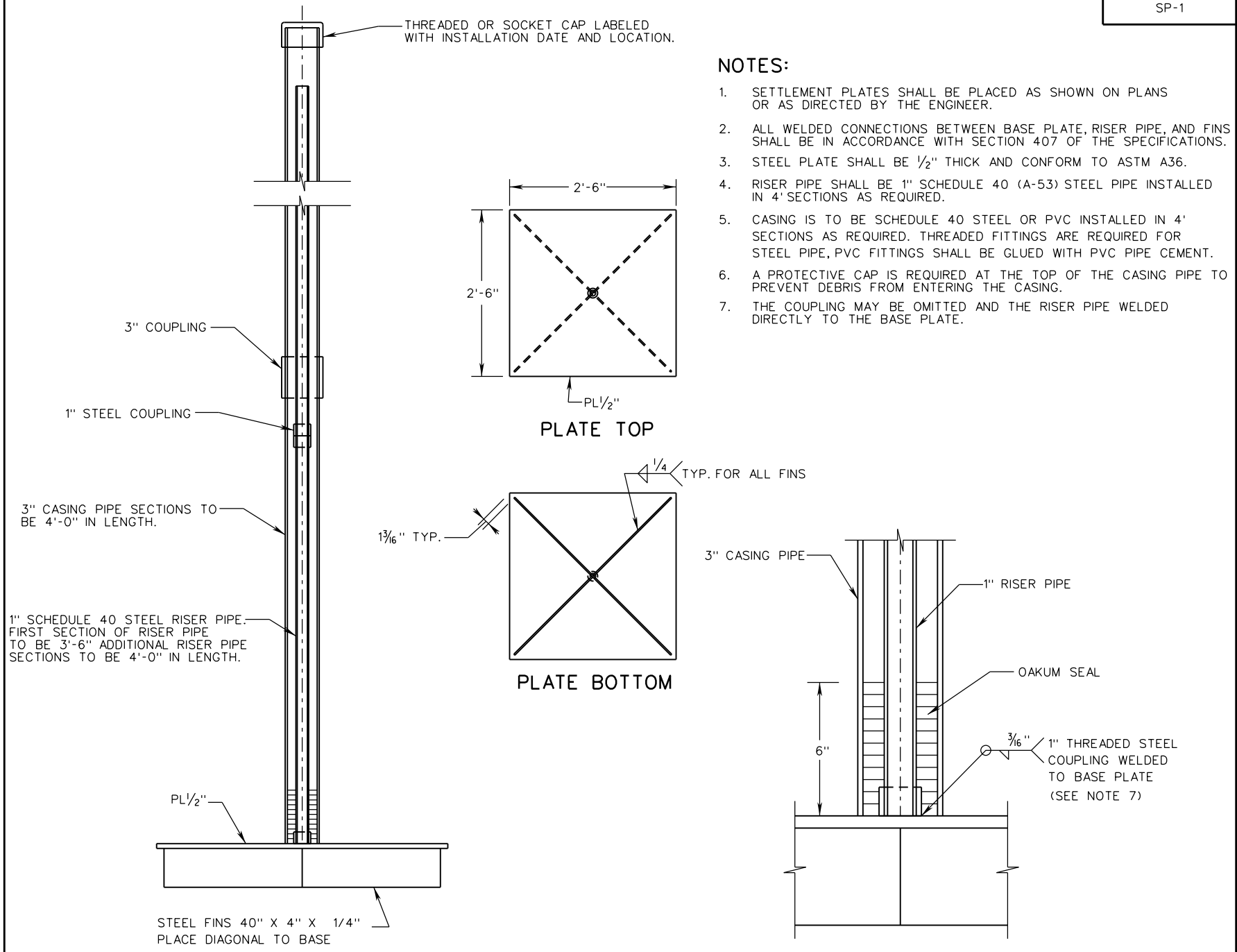

SPECIFICATION REFERENCE	A COPY OF THE ORIGINAL SEALED AND SIGNED DRAWING IS ON FILE IN THE CENTRAL OFFICE.		VDOT ROAD AND BRIDGE STANDARDS
	<b>SETTLEMENT PLATE</b>		
303 407	VIRGINIA DEPARTMENT OF TRANSPORTATION		SHEET 1 OF 1 601.07

SI-1

NOTE:  
 C OF ISLAND IS TO BE PERPENDICULAR TO C OF MAJOR ROUTE REGARDLESS OF THE ANGLE OF INTERSECTION.

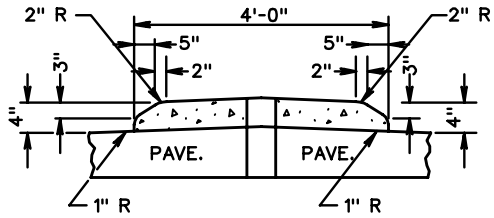

**SECTION A-A**

BASIS OF PAYMENT - EACH

0.5 CU. YDS CONCRETE TO BE CLASS A3 IF CAST IN PLACE, 4000 PSI IF PRECAST.

NOTE:  
 SIZE OF ISLAND IS TO BE GOVERNED BY OFFSETS FROM PAVEMENT EDGES & C AS SHOWN ON PLANS.

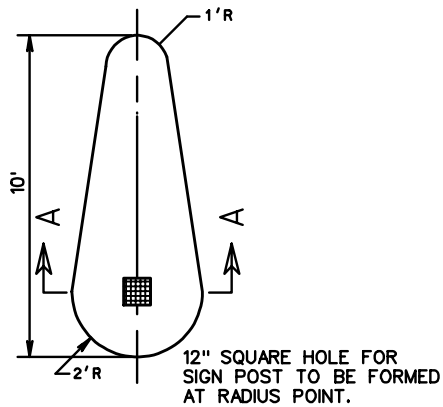

WHEN SIGN ISLAND IS INSTALLED OVER EXISTING PAVEMENT A HOLE FOR SIGN POST IS TO BE EXTENDED TO THE SUBBASE.

DETAIL OF STANDARD SIGN ISLAND

SI-2

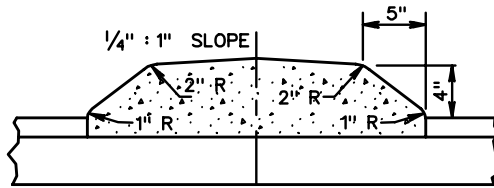

BASIS OF PAYMENT - SQUARE YARDS COMPLETE IN PLACE EXCLUSIVE OF POST AND SIGNS

NOTE:  
 SIZE OF ISLAND IS TO BE GOVERNED BY OFFSETS FROM PAVEMENT EDGES & C AS SHOWN ON PLANS.

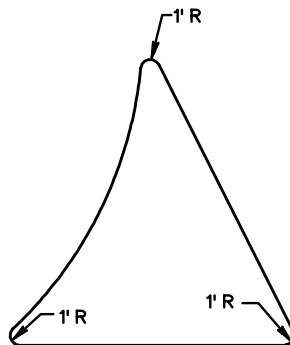
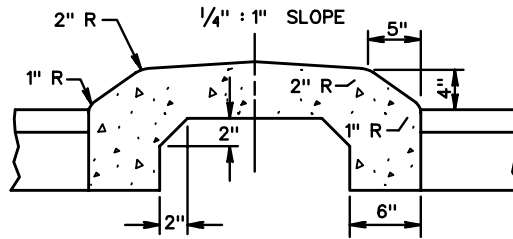

DESIGN OF STANDARD SIGN ISLAND

SI-3

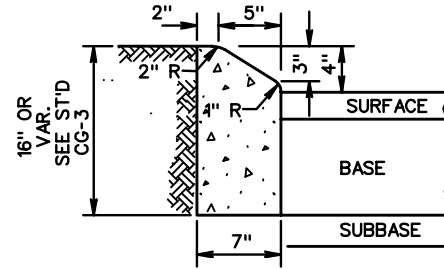

NOTE:

SIZE OF ISLAND IS TO BE GOVERNED BY OFFSETS FROM PAVEMENT EDGES & C AS SHOWN ON PLANS.

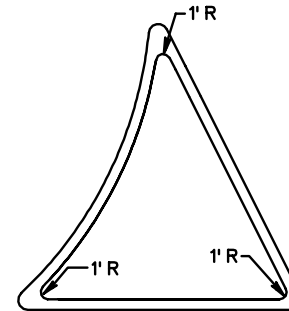

DETAIL OF DIRECTIONAL ISLAND CURB



ROAD AND BRIDGE STANDARDS

**STANDARD PLAN FOR SIGN ISLANDS**

SPECIFICATION REFERENCE

SHEET 1 OF 1

REVISION DATE

VIRGINIA DEPARTMENT OF TRANSPORTATION

105  
502

602.01

\* TO BE DETERMINED BY THE EXISTING CONDITIONS AT THE TIME OF CONSTRUCTION

- TYPE I - CRUSHER RUN AGGREGATE
- TYPE II - CONCRETE
- TYPE III - ASPHALT
- TYPE IV - ASPHALT COMMERCIAL

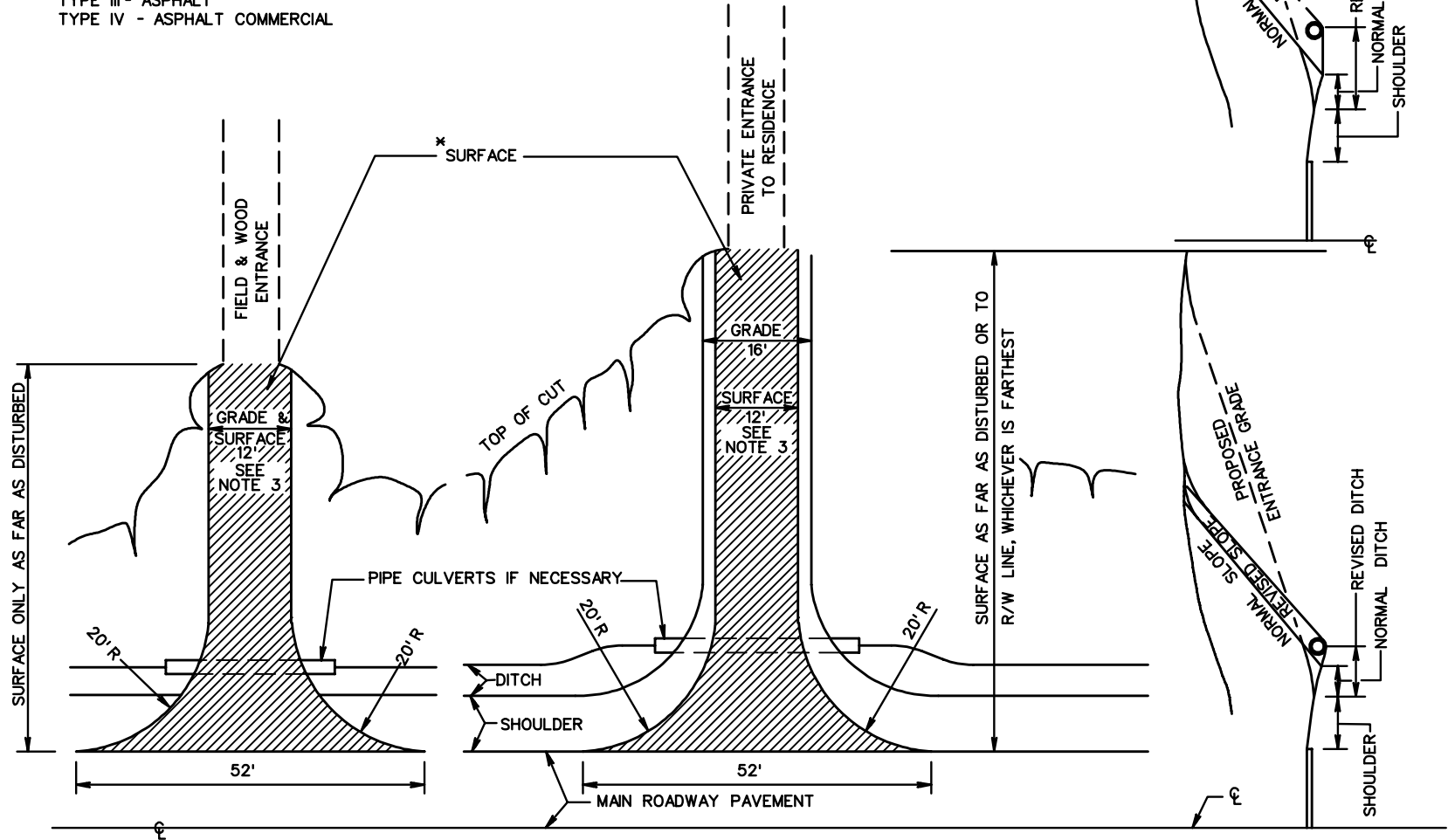

NOTES:

1. ALL ENTRANCE GRADES SHALL START BACK OF THE SHOULDER LINE. IF DRAINAGE IS NECESSARY, THE DITCH MAY BE MOVED BACK TO PROVIDE AT LEAST 9" OF COVER OVER PIPE, AS SHOWN IN THE ALTERNATE METHODS FOR PLACING PIPE UNDER ENTRANCES DIAGRAM.
2. ENTRANCE GRADES ARE TO BE SMOOTHLY TIED INTO THE ROADWAY BY ROUNDING AS NECESSARY.
3. 12' OR EXISTING WIDTH WHICHEVER IS GREATER.
4. LENGTHS OF CULVERTS SHOWN ON ROAD PLANS FOR ENTRANCES ARE APPROXIMATE AND SHALL BE ADJUSTED TO OBTAIN ABOVE ROADWAY WIDTHS.
5. ENTRANCES IN FILL TO BE SAME AS ABOVE EXCEPT LOCATION OF CULVERT (WHEN NECESSARY).

ALTERNATE METHODS FOR PLACING PIPES UNDER ENTRANCES

SPECIFICATION REFERENCE	<h2>STANDARD PRIVATE ENTRANCES</h2>	<b>VDOT</b> ROAD AND BRIDGE STANDARDS
512	VIRGINIA DEPARTMENT OF TRANSPORTATION	REVISION DATE      SHEET 1 OF 1
		602.02

CR-1

**EXAMPLES OF ALTERNATE MEDIAN DRAINAGE**

THESE ALTERNATIVES COULD BE CONSIDERED IN LIEU OF A PIPE UNDERNEATH THE MEDIAN CROSSOVER.

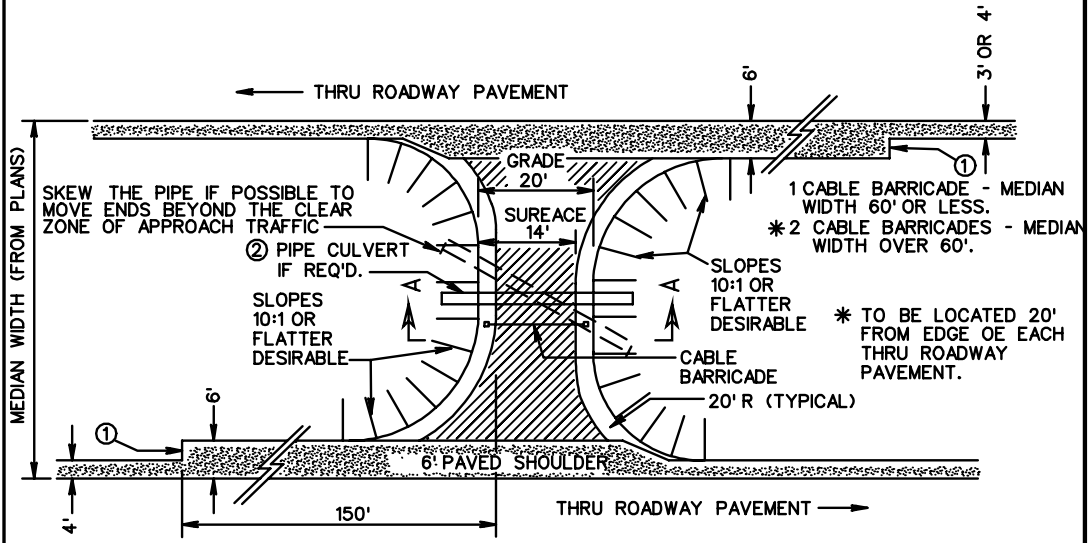
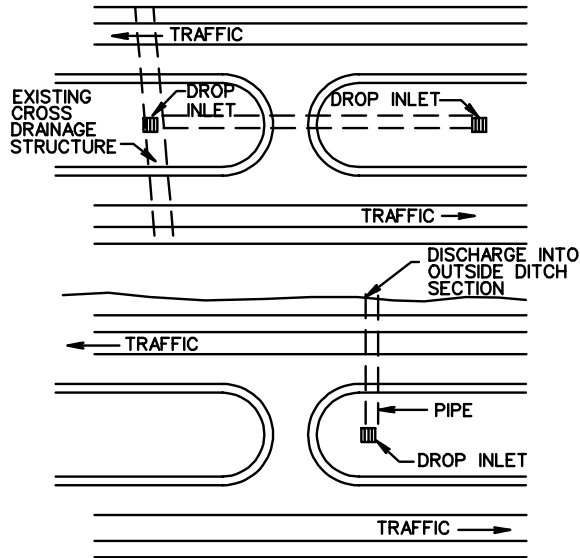

**PLAN**

- ① WIDEN PAVED PORTION OF MEDIAN SHOULDER OR 150' TO ACCOMMODATE TURNING VEHICLES.
- ② END TREATMENT AS REQUIRED TO MEET PROPOSED SLOPE.

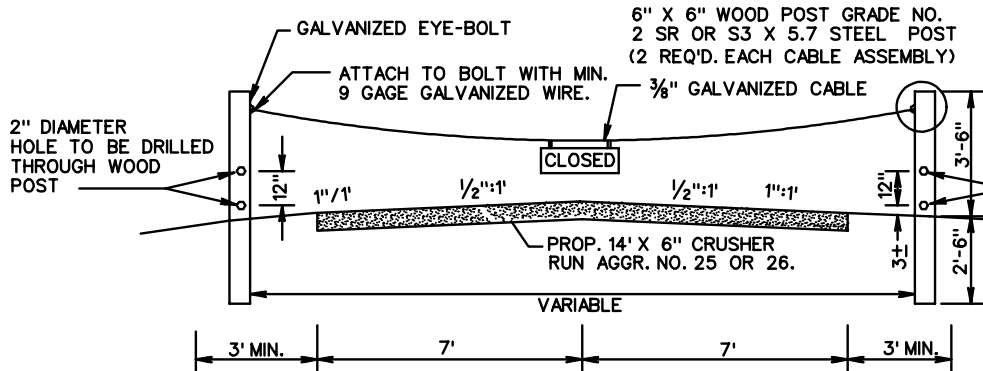

**SECTION A-A**

WOOD POSTS TO BE SALT TREATED OR PRIMED AND PAINTED DARK GREEN.

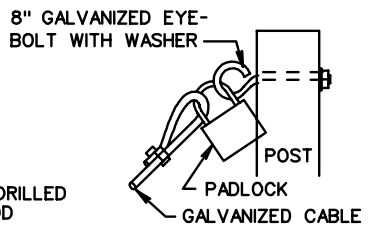

PADLOCK TO BE FURNISHED AND INSTALLED BY STATE FORCES UNLESS OTHERWISE SPECIFIED. CONTRACTOR TO TEMPORARILY ATTACH CABLE TO EYE-BOLT WITH MINIMUM 9 GAUGE GALVANIZED WIRE.

**\*\* SIGN**  
 MATERIAL: 0.080" ALUMINUM ALLOY 6061 - T6  
 SIZE : 24" X 9"  
 COLOR COMBINATION : C-1  
 BORDER WIDTH : 1/2"  
 MARGIN WIDTH : 1/2"  
 CORNER RADII : 1/2"  
 LETTER TYPE : L-1 OR L-2  
 LETTER HEIGHT AND SERIES : 4" - D  
**\*\*\* IN ACCORDANCE WITH V.D.O.T. "MANUAL OF UNIFORM TRAFFIC CONTROL DEVICES FOR STREETS AND HIGHWAYS".**  
**\*\* MESSAGE, BOTH SIDES IF ONE CABLE BARRICADE IS USED. MESSAGE, ONE SIDE IF TWO CABLE BARRICADES ARE USED.**

<b>VDOT</b>	
ROAD AND BRIDGE STANDARDS	
SHEET 1 OF 1	REVISION DATE
602.03	

**STANDARD MAINTENANCE CROSSOVER  
 FOR USE ON FREEWAYS**

VIRGINIA DEPARTMENT OF TRANSPORTATION

SPECIFICATION REFERENCE
505

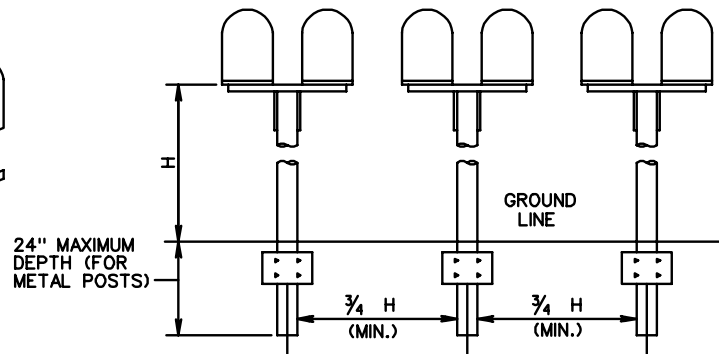
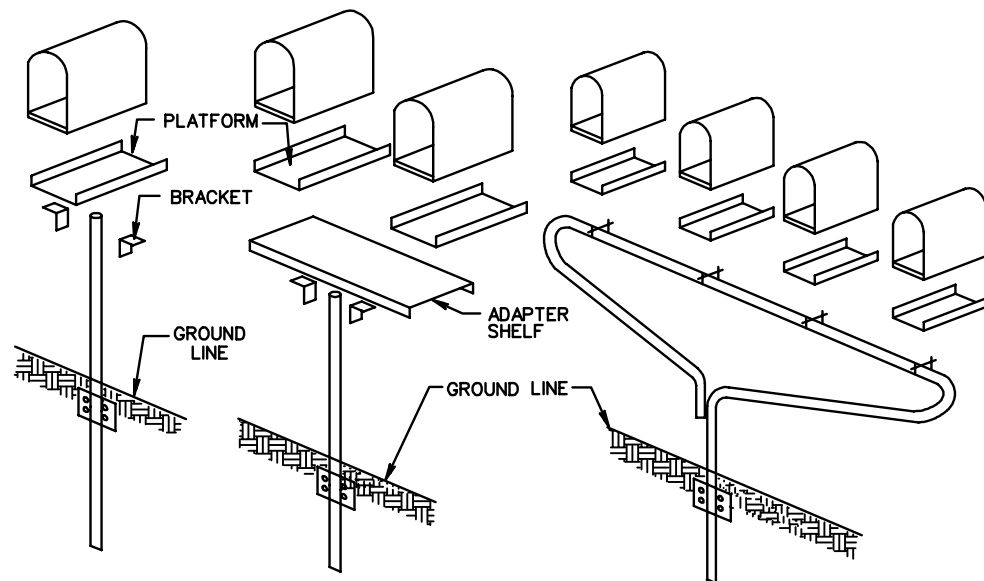

GROUPED

NOTES:

1. MAILBOXES SHALL BE OF LIGHT SHEET METAL OR PLASTIC CONSTR. CONFORMING TO THE REQUIREMENTS OF THE U.S. POSTAL SERVICE.
2. MAILBOX SUPPORTS SHALL NOT BE SET IN CONCRETE UNLESS THE SUPPORT DESIGN HAS BEEN SHOWN TO BE SAFE BY CRASH TESTS WHEN SO INSTALLED.
3. POSTS MAY BE 4" X 4" OR 4 1/2" DIAMETER WOOD POST, 2" DIAMETER STANDARD STRENGTH STEEL PIPE, OR OTHER STEEL OR ALUMINUM POST SHAPES OF EQUAL STRENGTHS.
4. THE POST-TO-BOX ATTACHMENT DETAILS SHOULD BE OF SUFFICIENT STRENGTH TO PREVENT THE BOX FROM SEPARATING FROM THE POST TOP IF THE INSTALLATION IS STRUCK BY A VEHICLE. HARDWARE SHOWN IS SUGGESTED ONLY, ALL GUIDELINES AS REQ'D. BY THE U.S. POSTAL SERVICE MUST BE FOLLOWED.

\* DIMENSIONS VARY ACCORDING TO THE SIZE OF THE MAIL BOX.

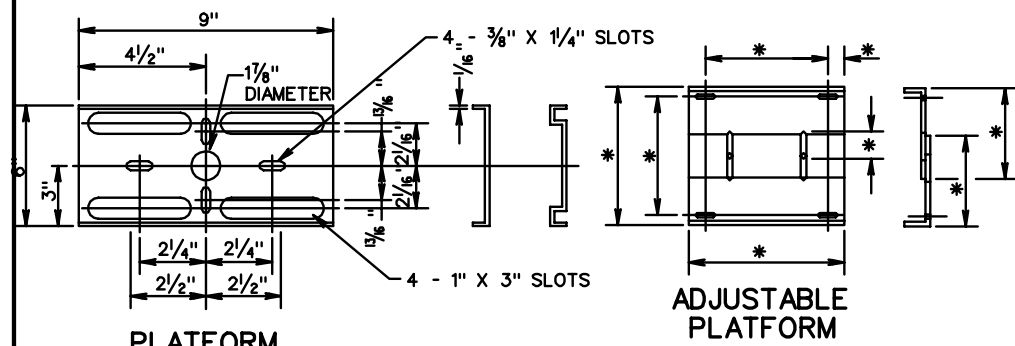

PLATFORM

ADJUSTABLE PLATFORM

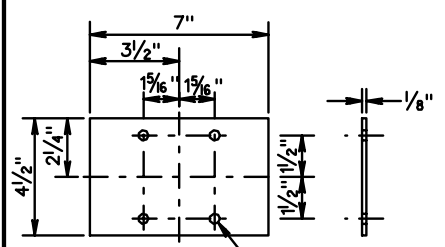

ANTI-TWIST PLATE

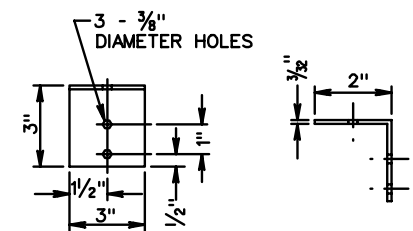

BRACKET

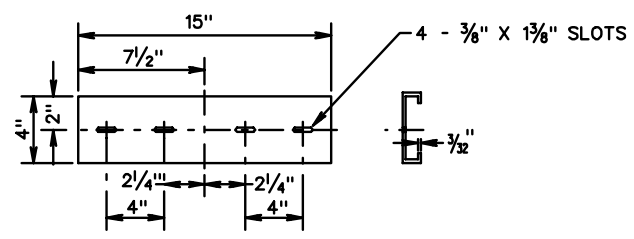

ADAPTER SHELF

SPECIFICATION REFERENCE
NONE

STANDARD MAILBOX

VIRGINIA DEPARTMENT OF TRANSPORTATION



ROAD AND BRIDGE STANDARDS

REVISION DATE	SHEET 1 OF 1
	603.01

RFD-1

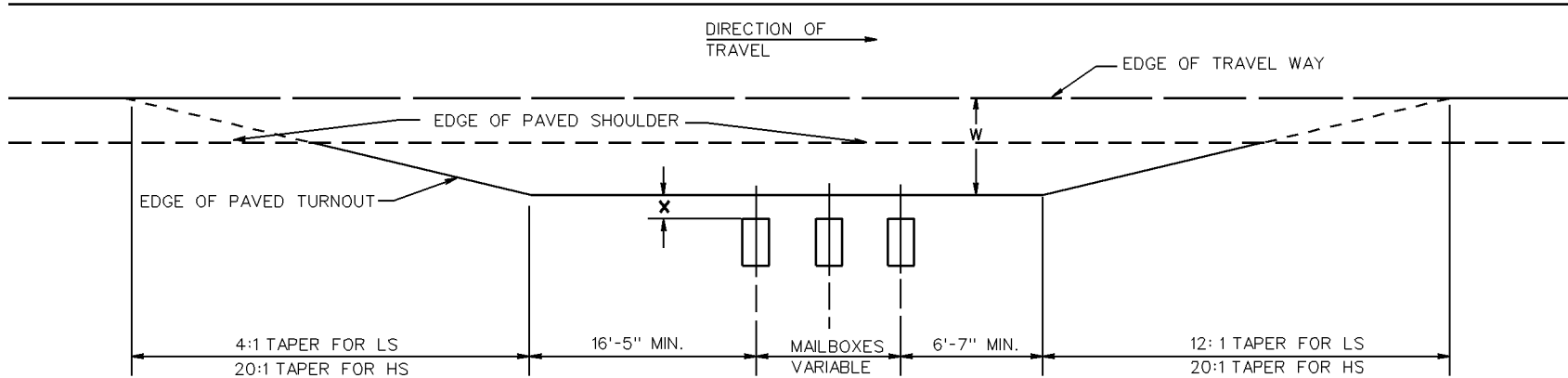

LS = A MINIMUM DESIGN FOR ROADS CARRYING LOW-SPEED TRAFFIC AND FOR LOCAL AND COLLECTOR ROADS.  
 HS = FOR ROADS CARRYING HIGH-SPEED TRAFFIC.  
 W = FOR SUGGESTED WIDTHS, SEE TABLE.  
 MAILBOXES = FOR MAILBOX SPACING AND VARIABLE LENGTH, SEE SHEET 603.01  
 X = 0" - 12" MAILBOX FACE OFFSET. SEE TABLE.

HIGHWAY TYPE AND ADT, (vpd)	WIDTH (W) OF ALL-WEATHER SURFACE TURNOUT OR AVAILABLE SHOULDER AT MAILBOX, (FT.) (SEE NOTE 1)		DISTANCE (X) FROM FACE OF MAILBOX IS TO BE OFFSET FROM EDGE OF TURNOUT OR USEABLE SHOULDER, (IN.)	
	PREFERRED	MINIMUM	PREFERRED	MINIMUM
RURAL HIGHWAY OVER 10,000	12	8	8 TO 12	0
RURAL HIGHWAY OVER 1,500 to 10,000	12	8		
RURAL HIGHWAY 400 to 1,500	10	8		
RURAL HIGHWAY UNDER 400	8	6 (SEE NOTE 2)		10 (SEE NOTE 3)
RESIDENTIAL STREET WITHOUT CURB OR ALL-WEATHER SHOULDER	6	0.00		
CURBED RESIDENTIAL STREET	NOT APPLICABLE		8 TO 12 (SEE NOTE 4)	6 (SEE NOTE 4)

ADT=AVERAGE DAILY TRAFFIC  
 vpd=VEHICLES PER DAY

**NOTES:**

- IF THERE IS A NEED TO PROVIDE FOR INCREASED ACCESS, THE FOLLOWING MAY BE CONSIDERED IN CONJUNCTION WITH THE LOCAL POSTMASTER
  - PROVIDE A LEVEL CLEAR FLOOR SPACE 30" X 48" CENTERED ON THE BOX FOR EITHER SIDE OR FORWARD APPROACH.
  - PROVIDE AN ACCESSIBLE PASSAGE TO AND FROM THE MAILBOX AND PROJECTION INTO A CIRCULATION ROUTE (NO MORE THAN 4" IF BETWEEN 28" AND 80" AFF) SO THAT THE MAILBOX DOES NOT BECOME A PROTRUDING OBJECT FOR PEDESTRIANS WITH IMPAIRED VISION.
- STRIVE FOR A 6 FEET MIN.; HOWEVER, IN SOME SITUATIONS THIS MAY NOT BE PRACTICAL. IN THOSE CASES, PROVIDE AS MUCH AS POSSIBLE.
- IF A TURNOUT IS PROVIDED, THIS MAY REDUCE TO ZERO.
- BEHIND TRAFFIC-FACE OF CURB.

**VDOT**  
 ROAD AND BRIDGE STANDARDS

SHEET 1 OF 1  
 603.02

REVISION DATE  
 08/10

**TURNOUT DETAIL**

VIRGINIA DEPARTMENT OF TRANSPORTATION

SPECIFICATION REFERENCE
302



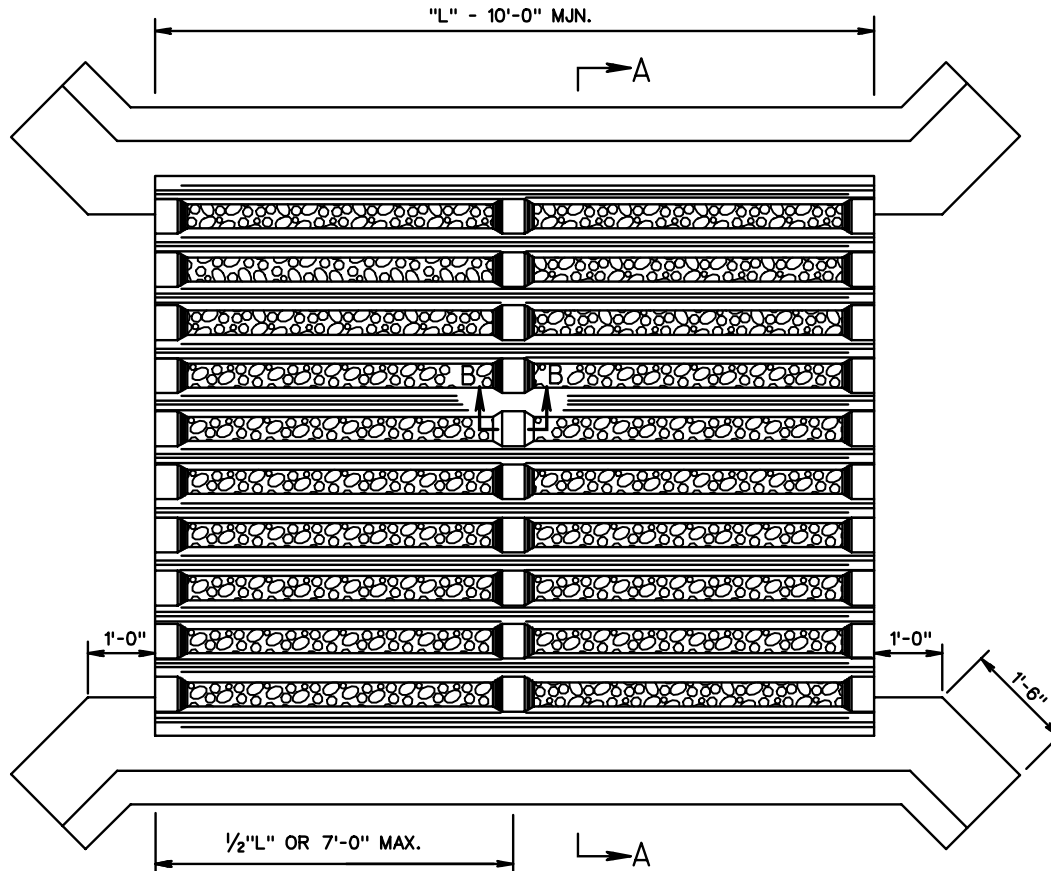

NOTES:  
 ANY MANUFACTURERS FABRICATION MEETING OR EXCEEDING THE MINIMUM DESIGN REQUIREMENTS DETAILED HEREON WILL BE ACCEPTABLE.  
 ALL CONCRETE IN PRECAST MEMBERS TO BE 4000 PSI CONCRETE IN FOOTING TO BE CLASS C1 OR CLASS A3.  
 LENGTH TO BE AS SHOWN ON PLANS.

MINIMUM SECTIONAL AREA OF MEMBERS

- INTERMEDIATE RAIL— 28 SQ. IN.
- SIDE RAIL — 50 SQ. IN.
- BEAM — 48 SQ. IN.

PLAN VIEW

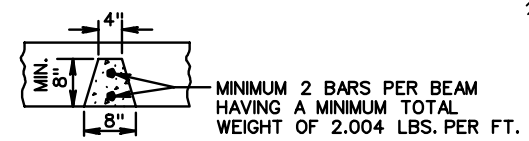

SECTION B-B  
 TYPICAL BEAM SECTION

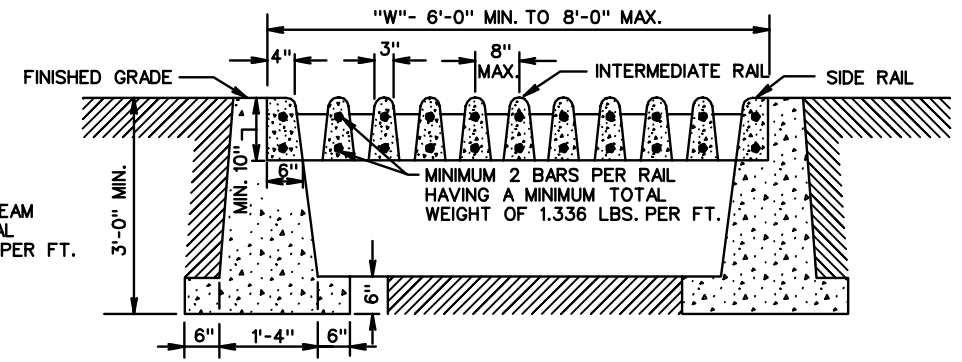

SECTION A-A

SPECIFICATION REFERENCE
302

PRECAST CONCRETE CATTLE GUARD

VIRGINIA DEPARTMENT OF TRANSPORTATION

<b>VDOT</b>	
ROAD AND BRIDGE STANDARDS	
REVISION DATE	SHEET 1 OF 1
	604.01

G-3A

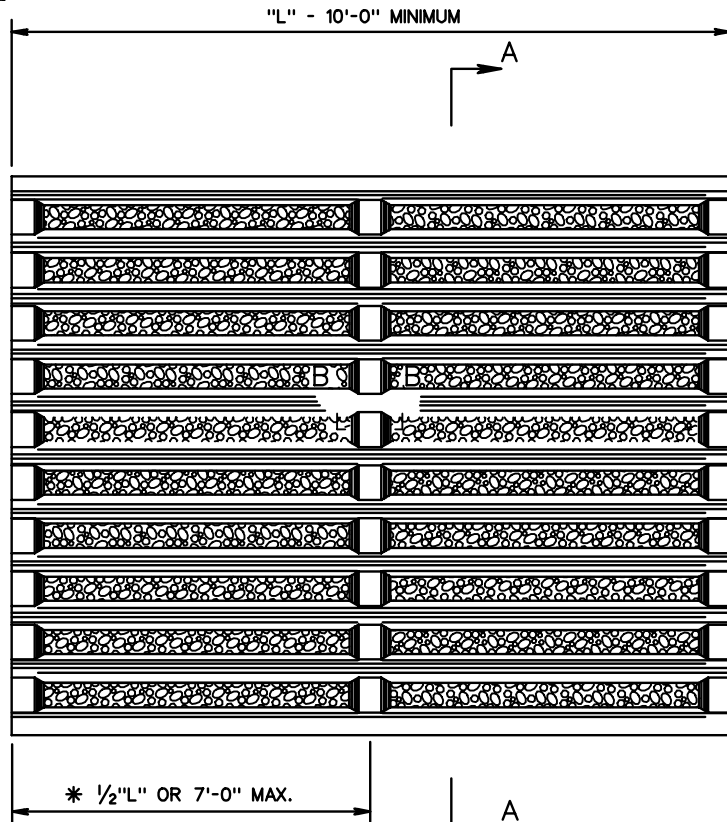

PLAN VIEW

NOTES:  
 ANY MANUFACTURERS FABRICATION MEETING OR EXCEEDING THE MINIMUM DESIGN REQUIREMENTS DETAILED HEREON WILL BE ACCEPTABLE.

ALL CONCRETE IN PRECAST MEMBERS TO BE 4000 PSI.

LENGTH TO BE AS SHOWN ON PLANS.

\* A RAIL SPACING OF 9 1/2" WOULD BE ALLOWED PROVIDED THE SPACE OF BEAMS DOES NOT EXCEED 3'.

MINIMUM SECTIONAL AREA OF MEMBERS

INTERMEDIATE RAIL - 28 SQ. IN.  
 SIDE RAIL - 50 SQ. IN.  
 BEAM - 48 SQ. IN.

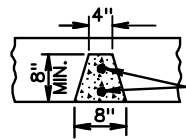

MIN. 2 BARS PER BEAM HAVING A MIN. TOTAL WEIGHT OF 2.004 LBS. PER FT.

SECTION B-B  
 TYPICAL BEAM SECTION

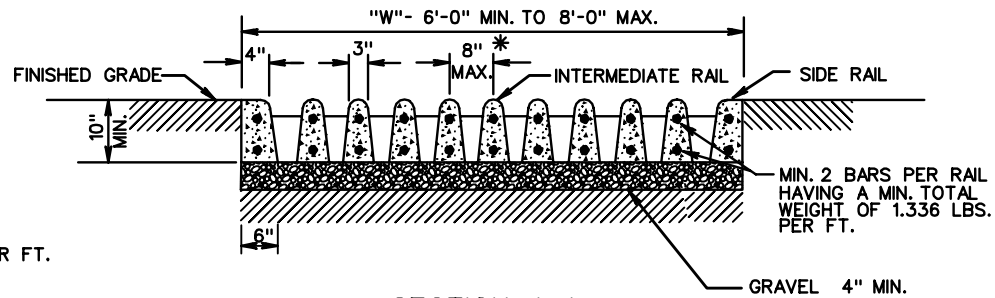

SECTION A-A

**VDOT**  
 ROAD AND BRIDGE STANDARDS

PRECAST CONCRETE CATTLE GUARD

SPECIFICATION REFERENCE

SHEET 1 OF 1

REVISION DATE

VIRGINIA DEPARTMENT OF TRANSPORTATION

302

604.02

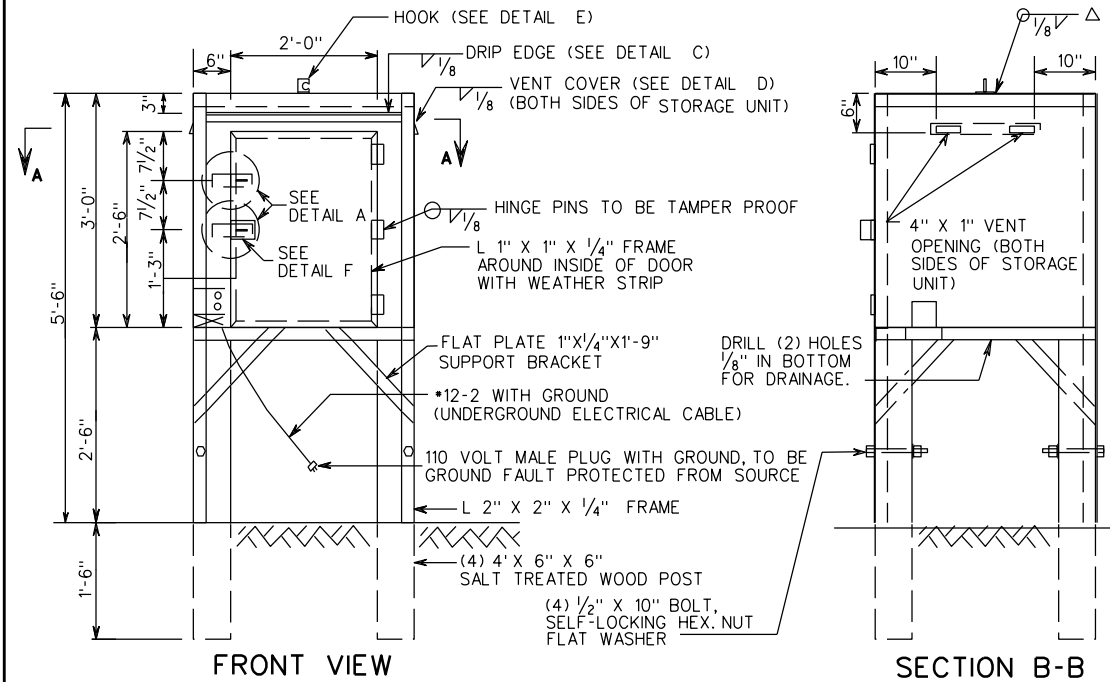

**NOTES:**

- NO SEPARATE PAYMENT WILL BE MADE FOR FURNISHING, INSTALLING AND PROVIDING MAINTENANCE OF THE STORAGE FACILITY FOR NUCLEAR GAUGE AND THE PRICE THEREOF SHALL BE INCLUDED IN THE PRICE BID FOR FIELD OFFICE (TYPE) SPECIFIED, IN ACCORDANCE WITH SECTION 514 OF THE CURRENT ROAD AND BRIDGE SPECIFICATIONS.
- BOX TO BE CONSTRUCTED OF A-36 SHEET STEEL  $\frac{1}{8}$ " MIN. THICKNESS. WHEN WELDING TO FRAME USE  $\frac{1}{8}$ " FILLET WELDS.
- ALL FRAME WORK IS TO BE A-36 STEEL ANGLE L 2" X 2" X  $\frac{1}{4}$ ".
- ALL FRAME WELDS ARE TO BE  $\frac{1}{4}$ " FILLET OR BUTT WELDED ACCORDINGLY.
- METAL SCREEN SHALL HAVE A MAXIMUM OF 50 SQUARES PER INCH TO A MINIMUM OF 25 SQUARES PER INCH AND BE SPOT WELDED TO INSIDE OF THE BOX OVER VENT OPENINGS.
- △ THE HOOK SHALL BE WELDED TO THE CENTER OF THE TOP.
- VENT OPENINGS SHALL BE PARTIALLY COVERED EXTERNALLY BY METAL VENT COVERS.
- STORAGE UNIT SHALL BE PAINTED INTERNALLY AND EXTERNALLY WITH A ONE COAT ACRYLIC DIRECT TO METAL (DTM) COATING, WITH A THICKNESS OF 4-6 MILS (WET MIL THICKNESS). COLOR SHALL BE EQUAL TO FEDERAL STANDARD COLOR NO. 595-17886 (WHITE).
- THE DESIGN IS TO BE 4" ID AND MOUNTED AT A 45° ANGLE OVER THE HASP OPENING IN THE DOOR.
- OPTIONAL SHROUD DESIGN IS TO BE SUBMITTED FOR THE ENGINEERS REVIEW AND APPROVAL.
- CONTRASTING PAINT IS REQUIRED TO DEPICT STORAGE AREA.
- STORAGE UNIT TO HAVE TWO (2) TAMPER-RESISTANT HASPS WITH A LOCK BOX EACH, OPEN ON THE BOTTOM AND TOP.
- A STEEL EYEBOLT SHALL BE INSTALLED IN THE FLOOR INSIDE THE CONTAINER TO ACCOMMODATE A LINKED SECURITY CHAIN. THE EYEBOLT MAY BE THROUGH BOLTED OR WELDED TO THE FLOOR AND SHALL HAVE A MINIMUM  $\frac{1}{2}$ " DIAMETER EYE TO ALLOW THE GAUGE TO BE CHAINED AND LOCKED TO THE FLOOR OF THE FACILITY.

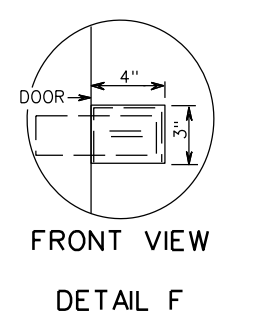
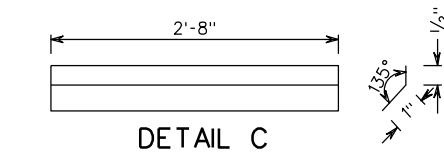
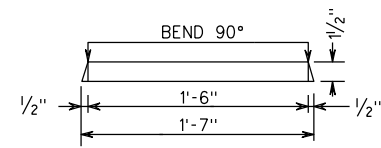
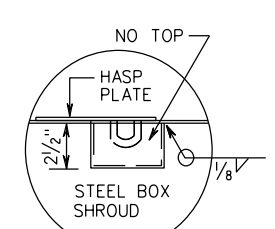
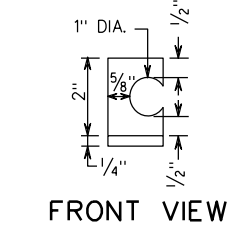
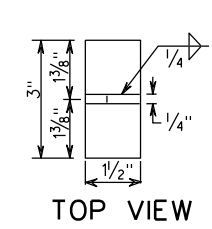
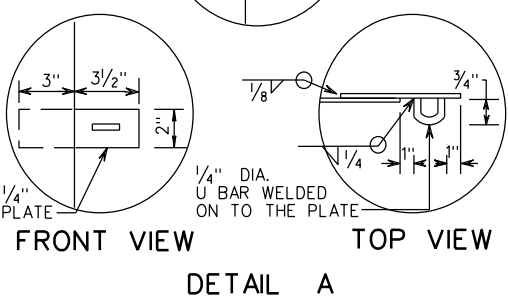
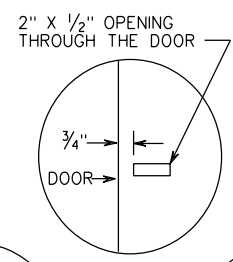
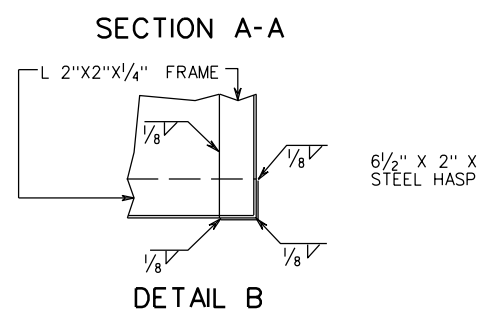
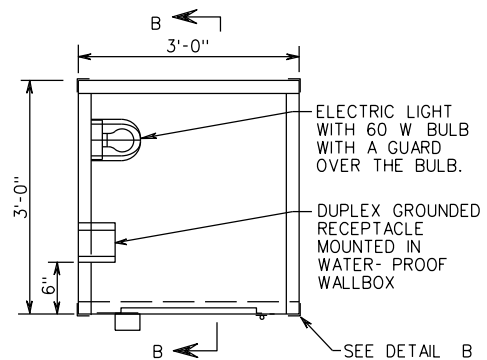

SPECIFICATION REFERENCE
-------------------------

STORAGE FACILITY FOR NUCLEAR GAUGE

VIRGINIA DEPARTMENT OF TRANSPORTATION

VDOT ROAD AND BRIDGE STANDARDS	
REVISION DATE 01/13	SHEET 1 OF 1 605.01

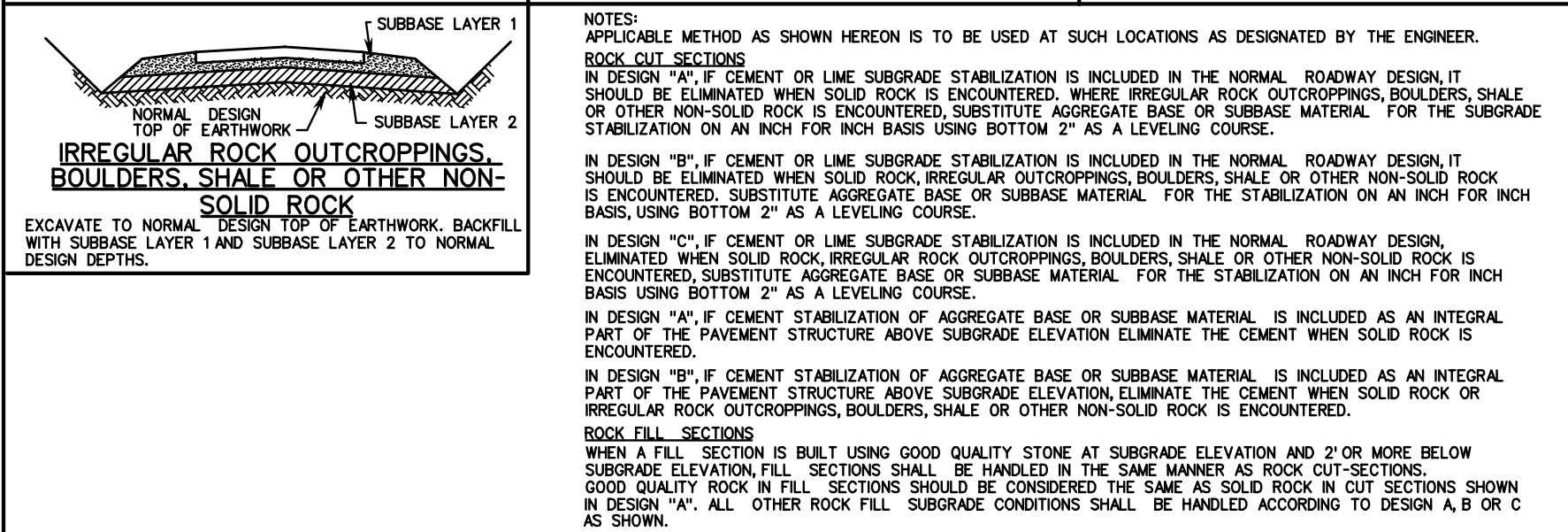
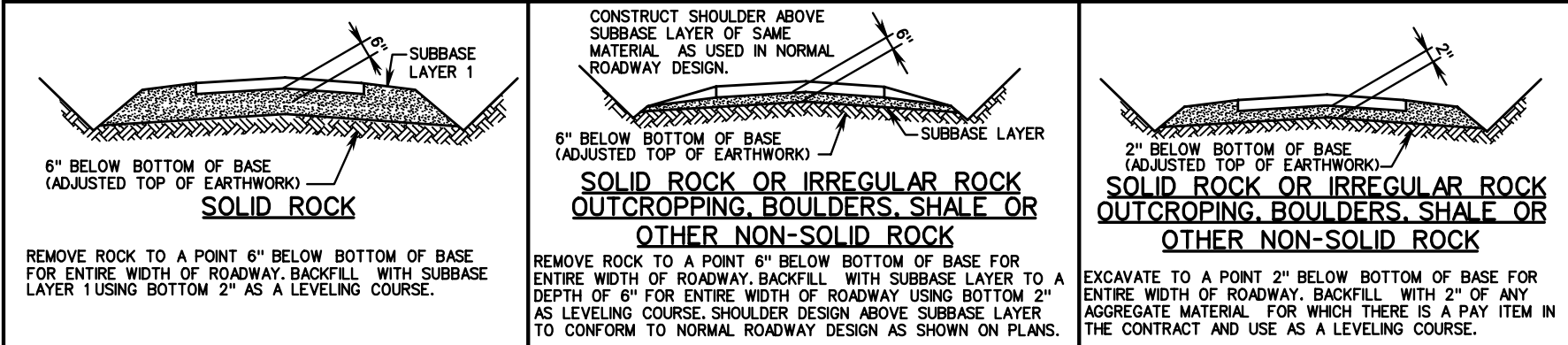
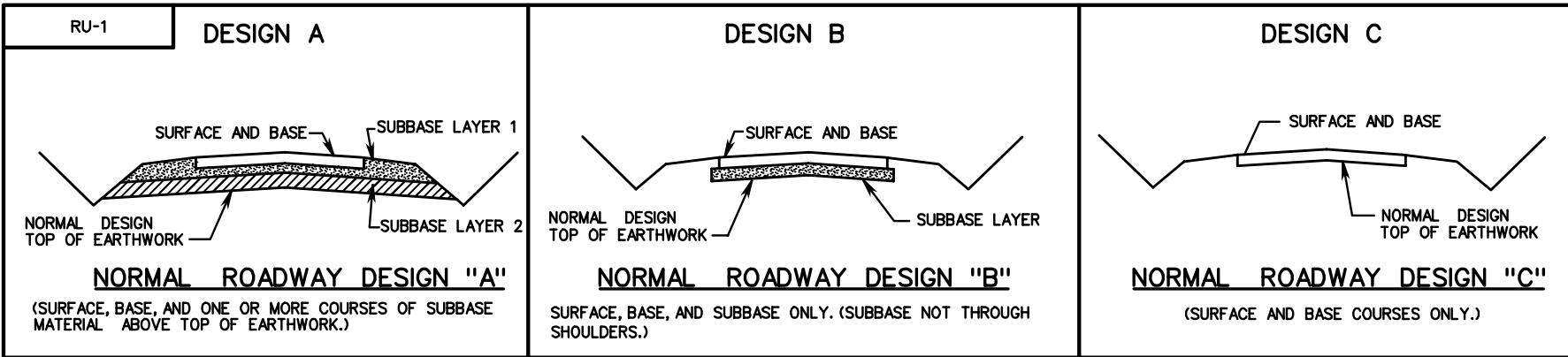

	<b>STANDARD METHODS OF UNDERCUTTING ROCK</b>	SPECIFICATION REFERENCE
ROAD AND BRIDGE STANDARDS		
SHEET 1 OF 1	REVISION DATE	303
606.01	VIRGINIA DEPARTMENT OF TRANSPORTATION	

### SLOPE STAKES ON TANGENTS

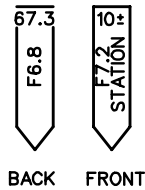
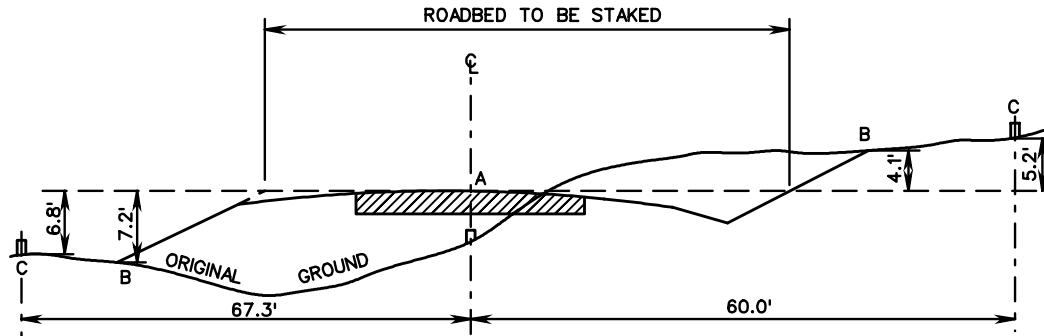

THE FRONT OF THE STAKE SHALL INDICATE THE CUT OR FILL TO THE SLOPE INTERSECTION (VERTICAL DISTANCE A TO B), THE OFFSET DISTANCE (B TO C), AND THE STATION.

THE BACK OF THE STAKE SHALL INDICATE THE CUT OR FILL AT THE POINT WHERE THE STAKE IS SET (VERTICAL DISTANCE A TO C), AND THE DISTANCE TO THE CENTERLINE (A TO C).

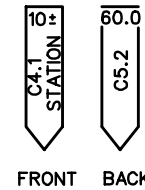

### SLOPE STAKES ON CURVES

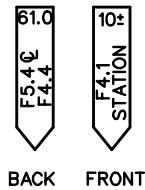
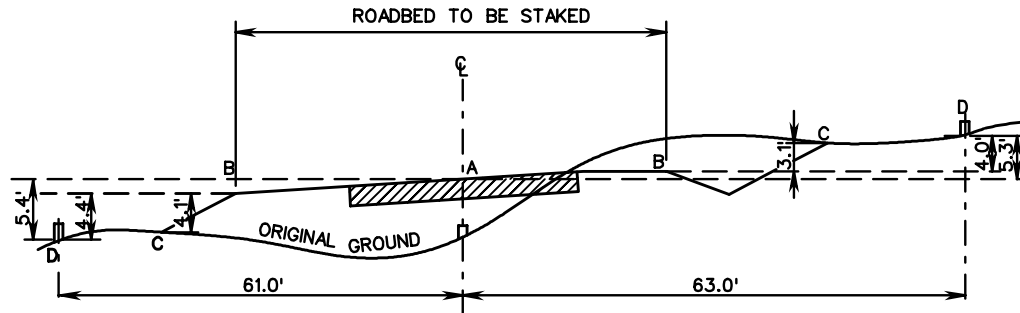

THE FRONT OF THE STAKE SHALL INDICATE THE CUT OR FILL TO THE SLOPE INTERSECTION INCLUDING SUPERELEVATION (VERTICAL DISTANCE B TO C), THE OFFSET DISTANCE (C TO D), AND THE STATION.

THE BACK OF THE STAKE SHALL INDICATE THE CUT OR FILL TO CENTERLINE AT THE POINT WHERE THE STAKE IS SET (VERTICAL DISTANCE A TO D), THE CUT OR FILL WHERE THE STAKE IS SET, INCLUDING SUPERELEVATION (VERTICAL DISTANCE B TO D), AND THE DISTANCE TO CENTERLINE (A TO D).

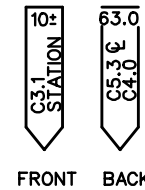

SPECIFICATION REFERENCE

105

# STANDARD METHOD OF SETTING AND MARKING SLOPE STAKES

VIRGINIA DEPARTMENT OF TRANSPORTATION

VDOT

ROAD AND BRIDGE STANDARDS

REVISION DATE

SHEET 1 OF 1

607.01

THIS PAGE INTENTIONALLY LEFT BLANK



ROAD AND BRIDGE STANDARDS

SHEET 1 OF 1

REVISION DATE

607.02

SPECIFICATION  
REFERENCE

VIRGINIA DEPARTMENT OF TRANSPORTATION

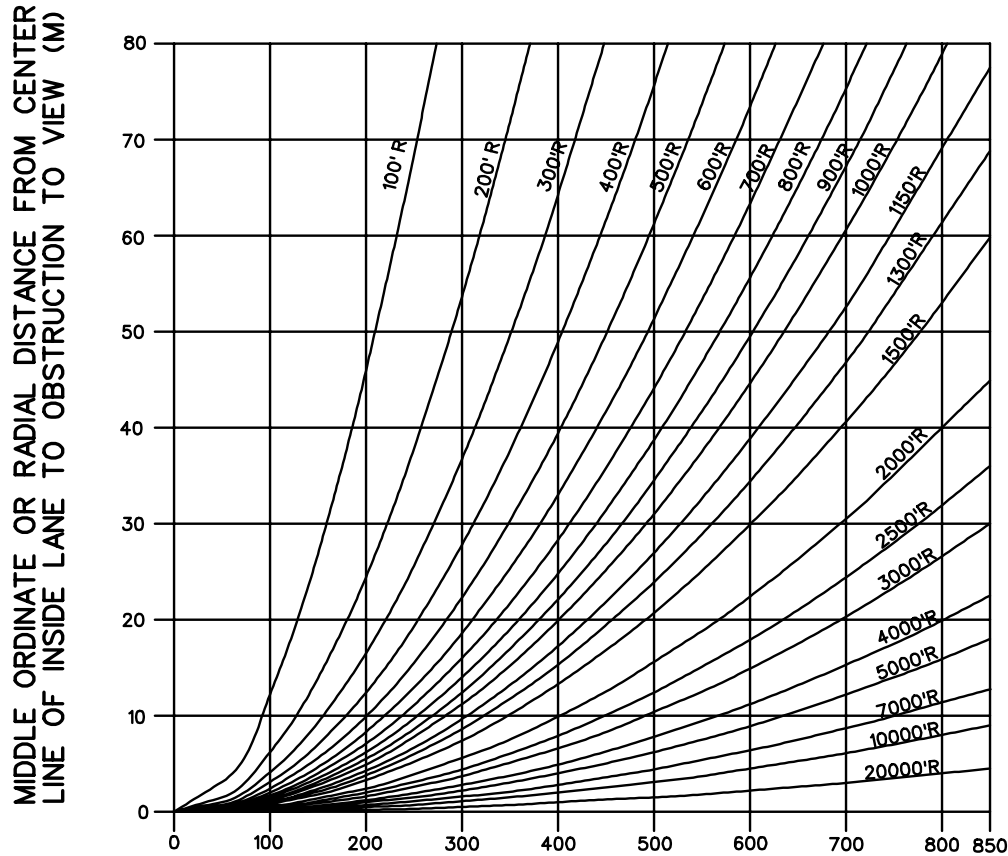

\* 2.0 FEET STOPPING  
 3.5 FEET PASSING  
 LINE OF SIGHT AT MID POINT TO  
 BE 2.0' ABOVE EDGE OF PAVE-  
 MENT FOR STOPPING SIGHT  
 DISTANCE, AND 4.0' FOR PASS-  
 ING SIGHT DISTANCE.

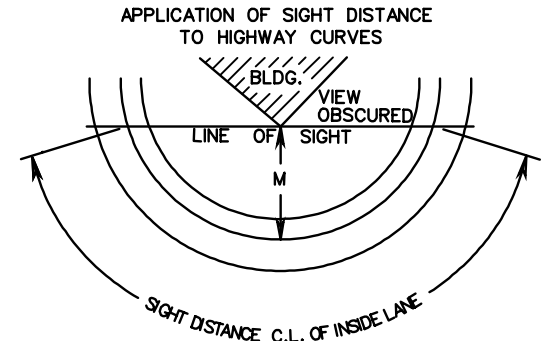

LENGTH OF ARC SUBTENDED OR CLEAR SIGHT DISTANCE  
 MEASURED ALONG CENTER LINE OF INSIDE LANE (S)

INTERMEDIATE VALUES OF S AND M NOT LISTED ON GRAPH CAN

MARK EQUAL TO 10' SIGHT DISTANCE (S) AND 1' OF RADIAL DISTANCE (M).

**SIGHT DISTANCES ON HORIZONTAL CURVES**  
**HEIGHT OF EYE 3.5 FT. : HEIGHT OF OBJECT 2.0 AND 3.5 FT.**

VIRGINIA DEPARTMENT OF TRANSPORTATION

**VDOT**

ROAD AND BRIDGE STANDARDS

REVISION DATE

SHEET 1 OF 1

608.01

2016 ROAD & BRIDGE STANDARDS

SD-2		WHEN S>L: $S = \frac{664.575}{A} + \frac{L}{2}$																			WHEN S<L: $S = 36.458 \sqrt{\frac{L}{A}}$	S = SIGHT DISTANCE IN FEET	A = ALGEBRAIC DIFFERENCE OF GRADES IN PERCENT
A = ALGEBRAIC DIFFERENCE OF GRADES IN PERCENT	L = LENGTH OF VERTICAL CURVE IN FEET																						
	50	100	150	200	250	300	350	400	450	500	550	600	650	700	750	800	850	900	950	1000			
2.0	357	382	407	432	457	482	507	532	557	582	607	632	657	682	706	729	752	773	795	815	2.0		
2.5	291	316	341	366	391	416	441	466	491	516	541	565	588	610	631	652	672	692	711	729	2.5		
3.0	247	272	297	322	347	372	397	422	447	471	494	516	537	557	576	595	614	631	649	666	3.0		
3.5	215	240	265	290	315	340	365	390	413	436	457	477	497	516	534	551	568	585	601	616	3.5		
4.0	191	216	241	266	291	316	341	365	387	408	428	447	465	482	499	516	531	547	562	576	4.0		
4.5	173	198	223	248	273	298	322	344	365	384	403	421	438	455	471	486	501	516	530	543	4.5		
5.0	158	183	208	233	258	282	305	326	346	365	382	399	416	431	447	461	475	489	503	516	5.0		
5.5	146	171	196	221	246	269	291	311	330	348	365	381	396	411	426	440	453	466	479	492	5.5		
6.0	136	161	186	211	235	258	278	298	316	333	349	365	379	394	408	421	434	447	459	471	6.0		
6.5	127	152	177	202	226	248	268	286	303	320	335	350	365	378	392	404	417	429	441	452	6.5		
7.0	120	145	170	195	218	239	258	276	292	308	323	338	351	365	377	390	402	413	425	436	7.0		
7.5	114	139	164	188	210	231	249	266	282	298	312	326	339	352	365	377	388	399	410	421	7.5		
8.0	108	133	158	182	204	223	241	258	273	288	302	316	329	341	353	365	376	387	397	408	8.0		
8.5	103	128	153	177	198	217	234	250	265	280	293	306	319	331	342	354	365	375	385	395	8.5		
9.0	99	124	149	172	192	210	227	243	258	272	285	298	310	322	333	344	354	365	375	384	9.0		
9.5	95	120	145	167	187	205	221	237	251	264	277	290	302	313	324	335	345	355	365	374	9.5		
10.0	91	116	141	163	182	200	216	231	245	258	270	282	294	305	316	326	336	346	355	365	10.0		
10.5	88	113	138	159	178	195	210	225	239	252	264	276	287	298	308	318	328	338	347	356	10.5		
11.0	85	110	135	155	174	190	206	220	233	246	258	269	280	291	301	311	320	330	339	348	11.0		
11.5	83	108	132	152	170	186	201	215	228	240	252	263	274	284	294	304	313	323	331	340	11.5		
12.0	80	105	129	149	166	182	197	210	223	235	247	258	268	278	288	298	307	316	324	333	12.0		
12.5	78	103	126	146	163	179	193	206	219	231	242	253	263	273	282	292	301	309	318	326	12.5		
13.0	76	101	124	143	160	175	189	202	215	226	237	248	258	268	277	286	295	303	312	320	13.0		
13.5	74	99	122	140	157	172	186	198	210	222	233	243	253	263	272	281	289	298	306	314	13.5		
14.0	72	97	119	138	154	169	182	195	207	218	229	239	248	258	267	276	284	292	300	308	14.0		
14.5	71	96	117	135	151	166	179	191	203	214	225	235	244	253	262	271	279	287	295	303	14.5		
15.0	69	94	115	133	149	163	176	188	200	210	221	231	240	249	258	266	274	282	290	298	15.0		
16.0	67	91	112	129	144	158	171	182	193	204	214	223	232	241	250	258	266	273	281	288	16.0		
17.0	64	88	108	125	140	153	165	177	188	198	207	217	225	234	242	250	258	265	273	280	17.0		
18.0	62	86	105	122	136	149	161	172	182	192	202	210	219	227	235	243	251	258	265	272	18.0		
19.0	60	84	102	118	132	145	156	167	177	187	196	205	213	221	229	237	244	251	258	264	19.0		
20.0	58	82	100	115	129	141	153	163	173	182	191	200	208	216	223	231	238	245	251	258	20.0		

**VDOT**  
ROAD AND BRIDGE STANDARDS

SHEET 1 OF 2      REVISION DATE

608.02

**SIGHT DISTANCE ON VERTICAL CURVES**

HEIGHT OF EYE = 3.5 FEET      HEIGHT OF OBJECT = 0.5 FEET

VIRGINIA DEPARTMENT OF TRANSPORTATION



2016 ROAD & BRIDGE STANDARDS

A = ALGEBRAIC DIFFERENCE OF GRADES IN PERCENT	WHEN S > L: $S = \frac{664.575}{A} + \frac{L}{2}$																			WHEN S < L: $S = 36.458 \sqrt{\frac{L}{A}}$																			SD-2	
	S = SIGHT DISTANCE IN FEET																																							
	L = LENGTH OF VERTICAL CURVE IN FEET																																							
	1050	1100	1150	1200	1250	1300	1350	1400	1450	1500	1550	1600	1650	1700	1750	1800	1850	1900	1950	2000	A = ALGEBRAIC DIFFERENCE OF GRADES IN PERCENT																			
2.0	835	855	874	893	911	930	947	965	982	998	1015	1031	1047	1063	1078	1094	1109	1124	1138	1153	2.0																			
2.5	747	765	782	799	815	831	847	863	878	893	908	922	937	951	965	978	992	1005	1018	1031	2.5																			
3.0	682	698	714	729	744	759	773	788	802	815	829	842	855	868	881	893	905	918	930	941	3.0																			
3.5	631	646	661	675	689	703	716	729	742	755	767	780	792	803	815	827	838	849	861	872	3.5																			
4.0	591	605	618	631	644	657	670	682	694	706	718	729	740	752	763	773	784	795	805	815	4.0																			
4.5	557	570	583	595	608	620	631	643	654	666	677	687	698	709	719	729	739	749	759	769	4.5																			
5.0	528	541	553	565	576	588	599	610	621	631	642	652	662	672	682	692	701	711	720	729	5.0																			
5.5	504	516	527	539	550	561	571	582	592	602	612	622	631	641	650	660	669	678	686	695	5.5																			
6.0	482	494	505	516	526	537	547	557	567	576	586	595	605	614	623	631	640	649	657	666	6.0																			
6.5	463	474	485	495	506	516	525	535	545	554	563	572	581	590	598	607	615	623	631	640	6.5																			
7.0	447	457	467	477	487	497	506	516	525	534	543	551	560	568	576	585	593	601	609	616	7.0																			
7.5	431	442	451	461	471	480	489	498	507	516	524	533	541	549	557	565	573	580	588	595	7.5																			
8.0	418	428	437	447	456	465	474	482	491	499	507	516	524	531	539	547	554	562	569	576	8.0																			
8.5	405	415	424	433	442	451	459	468	476	484	492	500	508	516	523	531	538	545	552	559	8.5																			
9.0	394	403	412	421	430	438	447	455	463	471	478	486	494	501	508	516	523	530	537	543	9.0																			
9.5	383	392	401	410	418	426	435	443	450	458	466	473	480	488	495	502	509	516	522	529	9.5																			
10.0	374	382	391	399	408	416	424	431	439	447	454	461	468	475	482	489	496	503	509	516	10.0																			
10.5	365	373	382	390	398	406	413	421	428	436	443	450	457	464	471	477	484	490	497	503	10.5																			
11.0	356	365	373	381	389	396	404	411	419	426	433	440	447	453	460	466	473	479	485	492	11.0																			
11.5	348	357	365	372	380	388	395	402	409	416	423	430	437	443	450	456	462	469	475	481	11.5																			
12.0	341	349	357	365	372	379	387	394	401	408	414	421	428	434	440	447	453	459	465	471	12.0																			
12.5	334	342	350	357	365	372	379	386	393	399	406	412	419	425	431	437	444	449	455	461	12.5																			
13.0	328	335	343	350	358	365	372	378	385	392	398	404	411	417	423	429	435	441	447	452	13.0																			
13.5	322	329	336	344	351	358	365	371	378	384	391	397	403	409	415	421	427	433	438	444	13.5																			
14.0	316	323	330	338	344	351	358	365	371	377	384	390	396	402	408	413	419	425	430	436	14.0																			
14.5	310	318	325	332	339	345	352	358	365	371	377	383	389	395	401	406	412	417	423	428	14.5																			
15.0	305	312	319	326	333	339	346	352	358	365	371	377	382	388	394	399	405	410	416	421	15.0																			
16.0	295	302	309	316	322	329	335	341	347	353	359	365	370	376	381	387	392	397	402	408	16.0																			
17.0	287	293	300	306	313	319	325	331	337	342	348	354	359	365	370	375	380	385	390	395	17.0																			
18.0	278	285	291	298	304	310	316	322	327	333	338	344	349	354	359	365	370	375	379	384	18.0																			
19.0	271	277	284	290	296	302	307	313	318	324	329	335	340	345	350	355	360	365	369	374	19.0																			
20.0	264	270	276	282	288	294	300	305	310	316	321	326	331	336	341	346	351	355	360	365	20.0																			

SIGHT DISTANCE ON VERTICAL CURVES

HEIGHT OF EYE = 3.5 FEET

HEIGHT OF OBJECT = 0.5 FEET

VIRGINIA DEPARTMENT OF TRANSPORTATION



ROAD AND BRIDGE STANDARDS

REVISION DATE

SHEET 2 OF 2

608.03

SD-3		WHEN S>L: $S = \frac{1546.362}{A} + \frac{L}{2}$																			WHEN S<L: $S = 55.612 \sqrt{\frac{L}{A}}$	S = SIGHT DISTANCE IN FEET	A = ALGEBRAIC DIFFERENCE OF GRADES IN PERCENT
A = ALGEBRAIC DIFFERENCE OF GRADES IN PERCENT	L = LENGTH OF VERTICAL CURVE IN FEET																						
	50	100	150	200	250	300	350	400	450	500	550	600	650	700	750	800	850	900	950	1000			
2.0	798	823	848	873	898	923	948	973	998	1023	1048	1073	1098	1123	1148	1173	1198	1223	1248	1273	2.0		
2.5	644	669	694	719	744	769	794	819	844	869	894	919	944	969	994	1019	1044	1069	1094	1119	2.5		
3.0	540	565	590	615	640	665	690	715	740	765	790	815	840	865	890	915	940	965	990	1015	3.0		
3.5	467	492	517	542	567	592	617	642	667	692	717	742	767	792	817	842	867	892	916	940	3.5		
4.0	412	437	462	487	512	537	562	587	612	637	662	687	712	737	762	786	811	834	857	879	4.0		
4.5	369	394	419	444	469	494	519	544	569	594	619	644	669	694	718	741	764	786	808	829	4.5		
5.0	334	359	384	409	434	459	484	509	534	559	584	609	634	658	681	703	725	746	767	786	5.0		
5.5	306	331	356	381	406	431	456	481	506	531	556	581	605	627	649	671	691	711	731	750	5.5		
6.0	283	308	333	358	383	408	433	458	483	508	532	556	579	601	622	642	662	681	700	718	6.0		
6.5	263	288	313	338	363	388	413	438	463	488	512	534	556	577	597	617	636	654	672	690	6.5		
7.0	246	271	296	321	346	371	396	421	446	470	493	515	536	556	576	595	613	631	648	665	7.0		
7.5	231	256	281	306	331	356	381	406	431	454	476	497	518	537	556	574	592	609	626	642	7.5		
8.0	218	243	268	293	318	343	368	393	417	440	461	482	501	520	538	556	573	590	606	622	8.0		
8.5	207	232	257	282	307	332	357	381	405	427	447	467	486	505	522	540	556	572	588	603	8.5		
9.0	197	222	247	272	297	322	347	371	393	415	435	454	473	490	508	524	540	556	571	586	9.0		
9.5	188	213	238	263	288	313	338	361	383	403	423	442	460	477	494	510	526	541	556	571	9.5		
10.0	180	205	230	255	280	305	329	352	373	393	412	431	448	465	482	497	513	528	542	556	10.0		
10.5	172	197	222	247	272	297	321	343	364	384	402	420	438	454	470	485	500	515	529	543	10.5		
11.0	166	191	216	241	266	290	314	335	356	375	393	411	427	444	459	474	489	503	517	530	11.0		
11.5	159	184	209	234	259	284	307	328	348	367	385	402	418	434	449	464	478	492	505	519	11.5		
12.0	154	179	204	229	254	278	300	321	341	359	376	393	409	425	440	454	468	482	495	508	12.0		
12.5	149	174	199	224	249	272	294	315	334	352	369	385	401	416	431	445	459	472	485	497	12.5		
13.0	144	169	194	219	244	267	289	308	327	345	362	378	393	408	422	436	450	463	475	488	13.0		
13.5	140	165	190	215	239	262	283	303	321	338	355	371	386	400	415	428	441	454	467	479	13.5		
14.0	135	160	185	210	235	257	278	297	315	332	349	364	379	393	407	420	433	446	458	470	14.0		
14.5	132	157	182	207	231	253	273	292	310	327	343	358	372	386	400	413	426	438	450	462	14.5		
15.0	128	153	178	203	227	249	269	287	305	321	337	352	366	380	393	406	419	431	443	454	15.0		
16.0	122	147	172	197	220	241	260	278	295	311	326	341	354	368	381	393	405	417	429	440	16.0		
17.0	116	141	166	191	213	234	252	270	286	302	316	330	344	357	369	381	393	405	416	427	17.0		
18.0	111	136	161	185	207	227	245	262	278	293	307	321	334	347	359	371	382	393	404	415	18.0		
19.0	106	131	156	180	202	221	239	255	271	285	299	313	325	338	349	361	372	383	393	403	19.0		
20.0	102	127	152	176	197	215	233	249	264	278	292	305	317	329	341	352	363	373	383	393	20.0		

**VDOT**  
ROAD AND BRIDGE STANDARDS

SHEET 1 OF 2      REVISION DATE

608.04

**SIGHT DISTANCE ON VERTICAL CURVES**

HEIGHT OF EYE = 3.5 FEET      HEIGHT OF OBJECT = 4.25 FEET

VIRGINIA DEPARTMENT OF TRANSPORTATION

A = ALGEBRAIC DIFFERENCE OF GRADES IN PERCENT	WHEN S > L: $S = \frac{1546.362}{A} + \frac{L}{2}$																			WHEN S < L: $S = 55.612\sqrt{\frac{L}{A}}$																			SD-3	
	S = SIGHT DISTANCE IN FEET																																							A = ALGEBRAIC DIFFERENCE OF GRADES IN PERCENT
L = LENGTH OF VERTICAL CURVE IN FEET																																								
	1050	1100	1150	1200	1250	1300	1350	1400	1450	1500	1550	1600	1650	1700	1750	1800	1850	1900	1950	2000																				
2.0	1298	1323	1348	1373	1398	1423	1448	1473	1498	1523	1548	1573	1597	1621	1645	1668	1691	1714	1736	1759	2.0																			
2.5	1144	1169	1194	1219	1244	1268	1292	1316	1339	1362	1385	1407	1429	1450	1471	1492	1513	1533	1553	1573	2.5																			
3.0	1040	1065	1089	1112	1135	1158	1180	1201	1223	1244	1264	1284	1304	1324	1343	1362	1381	1400	1418	1436	3.0																			
3.5	963	986	1008	1030	1051	1072	1092	1112	1132	1151	1170	1189	1207	1226	1244	1261	1279	1296	1313	1329	3.5																			
4.0	901	922	943	963	983	1003	1022	1040	1059	1077	1095	1112	1129	1146	1163	1180	1196	1212	1228	1244	4.0																			
4.5	849	869	889	908	927	945	963	981	998	1015	1032	1049	1065	1081	1097	1112	1128	1143	1158	1172	4.5																			
5.0	806	825	843	862	879	897	914	931	947	963	979	995	1010	1025	1040	1055	1070	1084	1098	1112	5.0																			
5.5	768	786	804	821	838	855	871	887	903	918	934	949	963	978	992	1006	1020	1034	1047	1060	5.5																			
6.0	736	753	770	786	803	819	834	849	865	879	894	908	922	936	950	963	977	990	1003	1015	6.0																			
6.5	707	723	740	756	771	786	801	816	831	845	859	873	886	899	912	925	938	951	963	975	6.5																			
7.0	681	697	713	728	743	758	772	786	800	814	828	841	854	867	879	892	904	916	928	940	7.0																			
7.5	658	673	689	703	718	732	746	760	773	786	799	812	825	837	849	862	873	885	897	908	7.5																			
8.0	637	652	667	681	695	709	722	736	749	761	774	786	799	811	823	834	846	857	868	879	8.0																			
8.5	618	633	647	661	674	688	701	714	726	739	751	763	775	786	798	809	820	831	842	853	8.5																			
9.0	601	615	629	642	655	668	681	694	706	718	730	741	753	764	775	786	797	808	819	829	9.0																			
9.5	585	598	612	625	638	651	663	675	687	699	710	722	733	744	755	765	776	786	797	807	9.5																			
10.0	570	583	596	609	622	634	646	658	670	681	692	703	714	725	736	746	756	767	777	786	10.0																			
10.5	556	569	582	595	607	619	631	642	654	665	676	686	697	708	718	728	738	748	758	768	10.5																			
11.0	543	556	569	581	593	605	616	627	638	649	660	671	681	691	701	711	721	731	740	750	11.0																			
11.5	531	544	556	568	580	591	603	614	624	635	646	656	666	676	686	696	705	715	724	733	11.5																			
12.0	520	532	544	556	568	579	590	601	611	622	632	642	652	662	672	681	691	700	709	718	12.0																			
12.5	510	522	533	545	556	567	578	589	599	609	619	629	639	649	658	667	677	686	695	703	12.5																			
13.0	500	512	523	534	545	556	567	577	587	597	607	617	627	636	645	654	663	672	681	690	13.0																			
13.5	490	502	513	524	535	546	556	566	576	586	596	605	615	624	633	642	651	660	668	677	13.5																			
14.0	482	493	504	515	525	536	546	556	566	576	585	595	604	613	622	631	639	648	656	665	14.0																			
14.5	473	484	495	506	516	527	537	546	556	566	575	584	593	602	611	620	628	637	645	653	14.5																			
15.0	465	476	487	497	508	518	528	537	547	556	565	574	583	592	601	609	618	626	634	642	15.0																			
16.0	451	461	471	482	492	501	511	520	529	538	547	556	565	573	582	590	598	606	614	622	16.0																			
17.0	437	447	457	467	477	486	496	505	514	522	531	540	548	556	564	572	580	588	596	603	17.0																			
18.0	425	435	445	454	463	473	482	490	499	508	516	524	532	540	548	556	564	571	579	586	18.0																			
19.0	413	423	433	442	451	460	469	477	486	494	502	510	518	526	534	541	549	556	563	571	19.0																			
20.0	403	412	422	431	440	448	457	465	474	482	490	497	505	513	520	528	535	542	549	556	20.0																			

## SIGHT DISTANCE ON VERTICAL CURVES

HEIGHT OF EYE = 3.5 FEET

HEIGHT OF OBJECT = 4.25 FEET

VIRGINIA DEPARTMENT OF TRANSPORTATION



ROAD AND BRIDGE STANDARDS

REVISION DATE

SHEET 2 OF 2

608.05

SD-4		WHEN S>L: $S = \frac{1079.15}{A} + \frac{L}{2}$																			A = ALGEBRAIC DIFFERENCE OF GRADES IN PERCENT	
		WHEN S<L: $S = 46.454 \sqrt{\frac{L}{A}}$																				
		S = SIGHT DISTANCE IN FEET																				
		L - LENGTH OF VERTICAL CURVE IN FEET																				
A = ALGEBRAIC DIFFERENCE OF GRADES IN PERCENT		50	100	150	200	250	300	350	400	450	500	550	600	650	700	750	800	850	900	950	1000	A = ALGEBRAIC DIFFERENCE OF GRADES IN PERCENT
2.0	565	590	615	640	665	690	715	740	765	790	815	840	865	890	915	940	965	990	1015	1040	2.0	
2.5	457	482	507	532	557	582	607	632	657	682	707	732	757	782	807	832	857	881	906	929	2.5	
3.0	385	410	435	460	485	510	535	560	585	610	635	660	685	710	735	759	782	805	827	848	3.0	
3.5	333	358	383	408	433	458	483	508	533	558	583	608	633	657	680	702	724	745	765	785	3.5	
4.0	295	320	345	370	395	420	445	470	495	520	545	569	592	615	636	657	677	697	716	735	4.0	
4.5	265	290	315	340	365	390	415	440	465	490	514	536	558	579	600	619	638	657	675	692	4.5	
5.0	241	266	291	316	341	366	391	416	441	465	487	509	530	550	569	588	606	623	640	657	5.0	
5.5	221	246	271	296	321	346	371	396	420	443	465	485	505	524	542	560	577	594	611	626	5.5	
6.0	205	230	255	280	305	330	355	379	402	424	445	465	484	502	519	536	553	569	585	600	6.0	
6.5	191	216	241	266	291	316	341	364	387	407	427	446	465	482	499	515	531	547	562	576	6.5	
7.0	179	204	229	254	279	304	328	351	372	393	412	430	448	465	481	497	512	527	541	555	7.0	
7.5	169	194	219	244	269	294	317	339	360	379	398	415	432	449	465	480	495	509	523	536	7.5	
8.0	160	185	210	235	260	284	307	328	348	367	385	402	419	435	450	465	479	493	506	519	8.0	
8.5	152	177	202	227	252	276	298	319	338	356	374	390	406	422	436	451	465	478	491	504	8.5	
9.0	145	170	195	220	245	268	290	310	328	346	363	379	395	410	424	438	451	465	477	490	9.0	
9.5	139	164	189	214	238	261	282	301	320	337	353	369	384	399	413	426	439	452	465	477	9.5	
10.0	133	158	183	208	232	254	275	294	312	328	345	360	375	389	402	415	428	441	453	465	10.0	
10.5	128	153	178	203	227	248	268	287	304	321	336	351	365	379	393	405	418	430	442	453	10.5	
11.0	123	148	173	198	221	243	262	280	297	313	328	343	357	371	384	396	408	420	432	443	11.0	
11.5	119	144	169	194	217	237	256	274	291	306	321	336	349	362	375	387	399	411	422	433	11.5	
12.0	115	140	165	190	212	232	251	268	284	300	314	328	342	355	367	379	391	402	413	424	12.0	
12.5	111	136	161	186	208	228	246	263	279	294	308	322	335	348	360	372	383	394	405	415	12.5	
13.0	108	133	158	182	204	223	241	258	273	288	302	316	328	342	353	364	376	387	397	407	13.0	
13.5	105	130	155	179	200	219	237	253	268	283	297	310	322	335	346	358	369	379	390	400	13.5	
14.0	102	127	152	176	196	215	232	248	263	278	291	304	317	328	340	351	362	372	383	393	14.0	
14.5	99	124	149	173	193	211	228	244	259	273	286	299	311	323	334	345	356	366	376	386	14.5	
15.0	97	122	147	170	190	208	224	240	254	268	281	294	306	317	328	339	350	360	370	379	15.0	
16.0	92	117	142	164	184	201	217	232	246	260	272	284	296	307	318	328	339	348	358	367	16.0	
17.0	88	113	138	159	178	195	211	225	239	252	264	276	287	298	309	319	328	338	347	356	17.0	
18.0	85	110	134	155	173	190	205	219	232	245	257	268	279	290	300	310	319	328	337	346	18.0	
19.0	82	107	131	151	169	185	199	213	226	238	250	261	272	282	292	301	311	320	328	337	19.0	
20.0	79	104	127	147	164	180	194	208	220	232	244	254	265	275	284	294	303	312	320	328	19.0	

**VDOT**  
ROAD AND BRIDGE STANDARDS

SHEET 1 OF 2      REVISION DATE

608.06

## STOPPING SIGHT DISTANCE ON CREST VERTICAL CURVES

HEIGHT OF EYE = 3.5 FEET      HEIGHT OF OBJECT = 2.00 FEET

VIRGINIA DEPARTMENT OF TRANSPORTATION

2016 ROAD & BRIDGE STANDARDS

A = ALGEBRAIC DIFFERENCE OF GRADES IN PERCENT	$\text{WHEN } S > L: S = \frac{1079.15}{A} + \frac{L}{2}$ $\text{WHEN } S < L: S = 46.454 \sqrt{\frac{L}{A}}$ $S = \text{SIGHT DISTANCE IN FEET}$																			SD-4	
	L = LENGTH OF VERTICAL CURVE IN FEET																			A = ALGEBRAIC DIFFERENCE OF GRADES IN PERCENT	
	1050	1100	1150	1200	1250	1300	1350	1400	1450	1500	1550	1600	1650	1700	1750	1800	1850	1900	1950		2000
2.0	1065	1089	1114	1138	1161	1184	1207	1229	1251	1272	1293	1314	1334	1354	1374	1394	1413	1432	1451	1469	2.0
2.5	952	974	996	1018	1039	1059	1079	1099	1119	1138	1157	1175	1193	1211	1229	1246	1264	1281	1297	1314	2.5
3.0	869	890	910	929	948	967	985	1004	1021	1039	1056	1073	1089	1106	1122	1138	1154	1169	1184	1199	3.0
3.5	805	824	842	860	878	895	912	929	946	962	978	993	1009	1024	1039	1053	1068	1082	1096	1110	3.5
4.0	753	770	788	805	821	837	853	869	884	900	914	929	943	958	972	985	999	1012	1026	1039	4.0
4.5	710	726	743	759	774	790	805	819	834	848	862	876	890	903	916	929	942	955	967	979	4.5
5.0	673	689	705	720	735	749	763	777	791	805	818	831	844	857	869	881	894	906	917	929	5.0
5.5	642	657	672	686	700	714	728	741	754	767	780	792	805	817	829	840	852	863	875	886	5.5
6.0	615	629	643	657	671	684	697	710	722	735	747	759	770	782	793	805	816	827	837	848	6.0
6.5	590	604	618	631	644	657	669	682	694	706	717	729	740	751	762	773	784	794	805	815	6.5
7.0	569	582	595	608	621	633	645	657	669	680	691	702	713	724	735	745	755	765	775	785	7.0
7.5	550	563	575	588	600	612	623	635	646	657	668	679	689	699	710	720	730	739	749	759	7.5
8.0	532	545	557	569	581	592	603	615	625	636	647	657	667	677	687	697	706	716	725	735	8.0
8.5	516	528	540	552	563	574	585	596	607	617	627	637	647	657	667	676	685	695	704	713	8.5
9.0	502	514	525	536	547	558	569	579	590	600	610	619	629	638	648	657	666	675	684	692	9.0
9.5	488	500	511	522	533	543	554	564	574	584	593	603	612	621	630	639	648	657	666	674	9.5
10.0	476	487	498	509	519	530	540	550	559	569	578	588	597	606	615	623	632	640	649	657	10.0
10.5	465	475	486	497	507	517	527	536	546	555	564	573	582	591	600	608	617	625	633	641	10.5
11.0	454	465	475	485	495	505	515	524	533	542	551	560	569	577	586	594	602	611	619	626	11.0
11.5	444	454	465	475	484	494	503	513	522	531	539	548	556	565	573	581	589	597	605	613	11.5
12.0	435	445	455	465	474	484	493	502	511	519	528	536	545	553	561	569	577	585	592	600	12.0
12.5	426	436	446	455	465	474	483	492	500	509	517	526	534	542	550	557	565	573	580	588	12.5
13.0	417	427	437	446	456	465	473	482	491	499	507	515	523	531	539	547	554	562	569	576	13.0
13.5	410	419	429	438	447	456	465	473	481	490	498	506	514	521	529	536	544	551	558	565	13.5
14.0	402	412	421	430	439	448	456	465	473	481	489	497	504	512	519	527	534	541	548	555	14.0
14.5	395	405	414	423	431	440	448	456	465	472	480	488	496	503	510	518	525	532	539	546	14.5
15.0	389	398	407	415	424	432	441	449	457	465	472	480	487	495	502	509	516	523	530	536	15.0
16.0	376	385	394	402	411	419	427	435	442	450	457	465	472	479	486	493	500	506	513	519	16.0
17.0	365	374	382	390	398	406	414	422	429	436	444	451	458	465	471	478	485	491	498	504	17.0
18.0	355	363	371	379	387	395	402	410	417	424	431	438	445	451	458	465	471	477	484	490	18.0
19.0	345	353	361	369	377	384	392	399	406	413	420	426	433	439	446	452	458	465	471	477	19.0
20.0	337	345	352	360	367	375	382	389	396	402	409	415	422	428	435	441	447	453	459	465	20.0

STOPPING SIGHT DISTANCE ON CREST VERTICAL CURVES

HEIGHT OF EYE = 3.5 FEET

HEIGHT OF OBJECT = 2.00 FEET

VIRGINIA DEPARTMENT OF TRANSPORTATION



ROAD AND BRIDGE STANDARDS

REVISION DATE

SHEET 2 OF 2

608.07

SD-5		WHEN S>L: $S = \frac{1400}{A} + \frac{L}{2}$																			WHEN S<L: $S = 52.915 \sqrt{\frac{L}{A}}$																			S = SIGHT DISTANCE IN FEET																			A = ALGEBRAIC DIFFERENCE OF GRADES IN PERCENT
A = ALGEBRAIC DIFFERENCE OF GRADES IN PERCENT	L = LENGTH OF VERTICAL CURVE IN FEET																																																										
	50	100	150	200	250	300	350	400	450	500	550	600	650	700	750	800	850	900	950	1000																																							
2.0	725	750	775	800	825	850	875	900	925	950	975	1000	1025	1050	1075	1100	1125	1150	1175	1200	2.0																																						
2.5	585	610	635	660	685	710	735	760	785	810	835	860	885	910	935	960	985	1010	1035	1060	2.5																																						
3.0	492	517	542	567	592	617	642	667	692	717	742	767	792	817	842	867	892	917	942	966	3.0																																						
3.5	425	450	475	500	525	550	575	600	625	650	675	700	725	750	775	800	825	849	872	894	3.5																																						
4.0	375	400	425	450	475	500	525	550	575	600	625	650	675	700	725	748	771	794	815	837	4.0																																						
4.5	336	361	386	411	436	461	486	511	536	561	586	611	636	660	683	706	727	748	769	789	4.5																																						
5.0	305	330	355	380	405	430	455	480	505	530	555	580	603	626	648	669	690	710	729	748	5.0																																						
5.5	280	305	330	355	380	405	430	455	480	505	529	553	575	597	618	638	658	677	695	714	5.5																																						
6.0	258	283	308	333	358	383	408	433	458	483	507	529	551	572	592	611	630	648	666	683	6.0																																						
6.5	240	265	290	315	340	365	390	415	440	464	487	508	529	549	568	587	605	623	640	656	6.5																																						
7.0	225	250	275	300	325	350	375	400	424	447	469	490	510	529	548	566	583	600	616	632	7.0																																						
7.5	212	237	262	287	312	337	362	386	410	432	453	473	493	511	529	547	563	580	596	611	7.5																																						
8.0	200	225	250	275	300	325	350	374	397	418	439	458	477	495	512	529	545	561	577	592	8.0																																						
8.5	190	215	240	265	290	315	340	363	385	406	426	445	463	480	497	513	529	544	559	574	8.5																																						
9.0	181	206	231	256	281	306	330	353	374	394	414	432	450	467	483	499	514	529	544	558	9.0																																						
9.5	172	197	222	247	272	297	321	343	364	384	403	421	438	454	470	486	501	515	529	543	9.5																																						
10.0	165	190	215	240	265	290	313	335	355	374	392	410	427	443	458	473	488	502	516	529	10.0																																						
10.5	158	183	208	233	258	283	306	327	346	365	383	400	416	432	447	462	476	490	503	516	10.5																																						
11.0	152	177	202	227	252	276	298	319	338	357	374	391	407	422	437	451	465	479	492	505	11.0																																						
11.5	147	172	197	222	247	270	292	312	331	349	366	382	398	413	427	441	455	468	481	493	11.5																																						
12.0	142	167	192	217	242	265	286	306	324	342	358	374	389	404	418	432	445	458	471	483	12.0																																						
12.5	137	162	187	212	237	259	280	299	317	335	351	367	382	396	410	423	436	449	461	473	12.5																																						
13.0	133	158	183	208	232	254	275	294	311	328	344	359	374	388	402	415	428	440	452	464	13.0																																						
13.5	129	154	179	204	228	249	269	288	306	322	338	353	367	381	394	407	420	432	444	455	13.5																																						
14.0	125	150	175	200	224	245	265	283	300	316	332	346	361	374	387	400	412	424	436	447	14.0																																						
14.5	122	147	172	197	220	241	260	278	295	311	326	340	354	368	381	393	405	417	428	439	14.5																																						
15.0	118	143	168	193	216	237	256	273	290	306	320	335	348	361	374	386	398	410	421	432	15.0																																						
16.0	113	138	163	187	209	229	247	265	281	296	310	324	337	350	362	374	386	397	408	418	16.0																																						
17.0	107	132	157	181	203	222	240	257	272	287	301	314	327	340	351	363	374	385	396	406	17.0																																						
18.0	103	128	153	176	197	216	233	249	265	279	292	306	318	330	342	353	364	374	384	394	18.0																																						
19.0	99	124	149	172	192	210	227	243	258	271	285	297	309	321	332	343	354	364	374	384	19.0																																						
20.0	95	120	145	167	187	205	221	237	251	265	277	290	302	313	324	335	345	355	365	374	20.0																																						

**VDOT**  
ROAD AND BRIDGE STANDARDS

SHEET 1 OF 2      REVISION DATE

608.08

## PASSING SIGHT DISTANCE ON CREST VERTICAL CURVES

HEIGHT OF EYE = 3.5 FEET      HEIGHT OF OBJECT = 3.5 FEET

VIRGINIA DEPARTMENT OF TRANSPORTATION

A = ALGEBRAIC DIFFERENCE OF GRADES IN PERCENT	WHEN S > L: $S = \frac{1400}{A} + \frac{L}{2}$																			WHEN S < L: $S = 52.915 \sqrt{\frac{L}{A}}$																			SD-5	
	L = LENGTH OF VERTICAL CURVE IN FEET																				S = SIGHT DISTANCE IN FEET																			
	1050	1100	1150	1200	1250	1300	1350	1400	1450	1500	1550	1600	1650	1700	1750	1800	1850	1900	1950	2000	A =	ALGEBRAIC DIFFERENCE OF GRADES IN PERCENT																		
2.0	1225	1250	1275	1300	1325	1350	1375	1400	1425	1449	1473	1497	1520	1543	1565	1587	1609	1631	1652	1673	2.0																			
2.5	1085	1100	1135	1159	1183	1207	1230	1252	1274	1296	1318	1339	1359	1380	1400	1420	1439	1459	1478	1497	2.5																			
3.0	990	1013	1036	1058	1080	1102	1122	1143	1163	1183	1203	1222	1241	1260	1278	1296	1314	1332	1349	1366	3.0																			
3.5	917	938	959	980	1000	1020	1039	1058	1077	1095	1114	1131	1149	1166	1183	1200	1217	1233	1249	1265	3.5																			
4.0	857	877	897	917	935	954	972	990	1007	1025	1042	1058	1075	1091	1107	1122	1138	1153	1168	1183	4.0																			
4.5	808	827	846	864	882	899	917	933	950	966	982	998	1013	1028	1043	1058	1073	1087	1102	1116	4.5																			
5.0	767	785	802	820	837	853	869	885	901	917	932	947	961	976	990	1004	1018	1032	1045	1058	5.0																			
5.5	731	748	765	782	798	814	829	844	859	874	888	903	917	930	944	957	970	983	996	1009	5.5																			
6.0	700	716	733	748	764	779	794	808	823	837	850	864	877	891	904	917	929	942	954	966	6.0																			
6.5	673	688	704	719	734	748	763	777	790	804	817	830	843	856	868	881	893	905	917	928	6.5																			
7.0	648	663	678	693	707	721	735	748	762	775	787	800	812	825	837	849	860	872	883	894	7.0																			
7.5	626	641	655	669	683	697	710	723	736	748	761	773	785	797	808	820	831	842	853	864	7.5																			
8.0	606	620	634	648	661	675	687	700	712	725	737	748	760	771	783	794	805	815	826	837	8.0																			
8.5	588	602	615	629	642	654	667	679	691	703	715	726	737	748	759	770	781	791	801	812	8.5																			
9.0	572	585	598	611	624	636	648	660	672	683	694	706	716	727	738	748	759	769	779	789	9.0																			
9.5	556	569	582	595	607	619	631	642	654	665	676	687	697	708	718	728	738	748	758	768	9.5																			
10.0	542	555	567	580	592	603	615	626	637	648	659	669	680	690	700	710	720	729	739	748	10.0																			
10.5	529	542	554	566	577	589	600	611	622	632	643	653	663	673	683	693	702	712	721	730	10.5																			
11.0	517	529	541	553	564	575	586	597	608	618	628	638	648	658	667	677	686	695	705	714	11.0																			
11.5	506	518	529	541	552	563	573	584	594	604	614	624	634	643	653	662	671	680	689	698	11.5																			
12.0	495	507	518	529	540	551	561	572	582	592	601	611	620	630	639	648	657	666	675	683	12.0																			
12.5	485	496	508	518	529	540	550	560	570	580	589	599	608	617	626	635	644	652	661	669	12.5																			
13.0	476	487	498	508	519	529	539	549	559	568	578	587	596	605	614	623	631	640	648	656	13.0																			
13.5	467	478	488	499	509	519	529	539	548	558	567	576	585	594	602	611	619	628	636	644	13.5																			
14.0	458	469	480	490	500	510	520	529	539	548	557	566	574	583	592	600	608	616	624	632	14.0																			
14.5	450	461	471	481	491	501	511	520	529	538	547	556	564	573	581	590	598	606	614	621	14.5																			
15.0	443	453	463	473	483	493	502	511	520	529	538	547	555	563	572	580	588	596	603	611	15.0																			
16.0	429	439	449	458	468	477	486	495	504	512	521	529	537	545	553	561	569	577	584	592	16.0																			
17.0	416	426	435	445	454	463	472	480	489	497	505	513	521	529	537	544	552	559	567	574	17.0																			
18.0	404	414	423	432	441	450	458	467	475	483	491	499	507	514	522	529	536	544	551	558	18.0																			
19.0	393	403	412	421	429	438	446	454	462	470	478	486	493	501	508	515	522	529	536	543	19.0																			
20.0	383	392	401	410	418	427	435	443	451	458	466	473	481	488	495	502	509	516	522	529	20.0																			

PASSING SIGHT DISTANCE ON CREST VERTICAL CURVES

HEIGHT OF EYE = 3.5 FEET

HEIGHT OF OBJECT = 3.5 FEET

VIRGINIA DEPARTMENT OF TRANSPORTATION



ROAD AND BRIDGE STANDARDS

REVISION DATE

SHEET 2 OF 2

608.09

THIS PAGE INTENTIONALLY LEFT BLANK



ROAD AND BRIDGE STANDARDS

SHEET 1 OF 1

REVISION DATE

608.10

SPECIFICATION  
REFERENCE

VIRGINIA DEPARTMENT OF TRANSPORTATION